

VocoPro

ULTIMATE CHOICE OF KARAOKE ENTERTAINMENT

OWNER'S MANUAL

THE BRAVO! DIGITAL CDG AND CASSETTE KARAOKE PLAYER

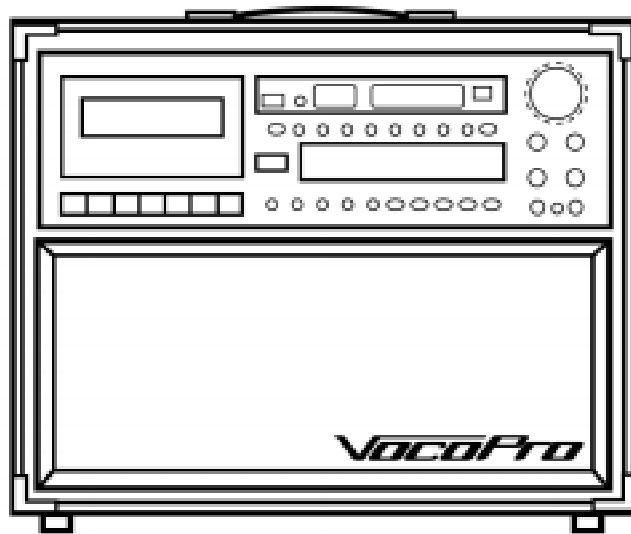

IMPORTANT INFORMATION: Thank you for choosing The Bravo. To make full and effective use of this unit, please read this Owner's Manual carefully before operating.

GENERAL WARNING

CAUTION

**RISK OF ELECTRIC SHOCK
DO NOT OPEN**

CAUTION: TO REDUCE RISK OF ELECTRIC SHOCK, DO NOT REMOVE COVER (OR BACK). NO USER-SERVICEABLE PARTS INSIDE. REFER SERVICING TO QUALIFIED SERVICE PERSONNEL

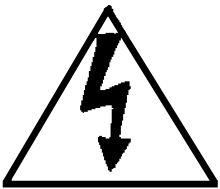

The lightning flash with arrowhead symbol, within an equilateral triangle is intended to alert the user to the presence of -insulated “dangerous voltage” within the product’s enclosure that may be of sufficient magnitude to constitute a risk of electric shock to persons.



The exclamation point within an equilateral triangle, is intended to alert the user to the presence of important operating and maintenance (servicing) instructions in the literature accompanying the appliance.

GENERAL SAFETY PRECAUTIONS



1. **READ INSTRUCTIONS** - ALL THE SAFETY AND OPERATION INSTRUCTIONS SHOULD BE READ BEFORE THE BRAVO IS OPERATED.
2. **RETAIN INSTRUCTIONS AND PACKAGING** - THE SAFETY AND OPERATING INSTRUCTIONS SHOULD BE KEPT FOR FUTURE REFERENCE. ALSO KEEP THE BOX IN CASE THE UNIT NEEDS TO BE RETURNED FOR SERVICE.
3. **HEED WARNINGS** - ALL WARNINGS ON THE BRAVO AND IN THESE OPERATING INSTRUCTIONS SHOULD BE FOLLOWED.
4. **FOLLOW INSTRUCTIONS** - ALL OPERATING AND OTHER INSTRUCTIONS SHOULD BE FOLLOWED.
5. **WATER AND MOISTURE** - THE BRAVO SHOULD NOT BE USED NEAR WATER - FOR EXAMPLE, NEAR A BATHTUB, WASHBOWL, KITCHEN SINK, LAUNDRY TUB, IN A WET BASEMENT, OR SWIMMING POOL.
6. **HEAT** - THE BRAVO SHOULD BE SITUATED AWAY FROM HEAT SOURCES SUCH AS RADIATORS, OR OTHER DEVICES WHICH PRODUCE HEAT.
7. **POWER CORD PROTECTION** - POWER SUPPLY CORDS SHOULD BE ROUTED SO THAT THEY ARE NOT LIKELY TO BE WALKED UPON OR PINCHED BY ITEMS PLACED UPON OR AGAINST THEM, PAYING PARTICULAR ATTENTION TO CORDS AT PLUGS, CONVENIENCE RECEPTACLES, AND THE POINT WHERE THEY EXIT THE BRAVO.
8. **OBJECT AND LIQUID ENTRY** - CARE SHOULD BE TAKEN SO THAT OBJECTS DO NOT FALL INTO AND LIQUIDS ARE NOT SPILLED INTO THE INSIDE OF THE BRAVO.
9. **SERVICE** - BRAVO SHOULD BE SERVICED BY QUALIFIED SERVICE PERSONNEL. THE USER SHOULD NOT ATTEMPT TO SERVICE BRAVO. DOING SO MAY VOID THE WARRANTY.

THE BRAVO FEATURES

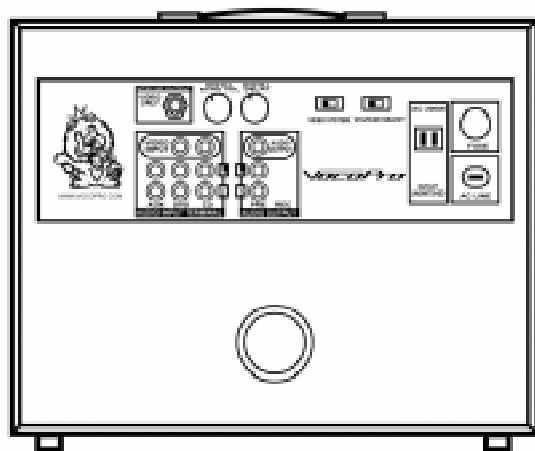
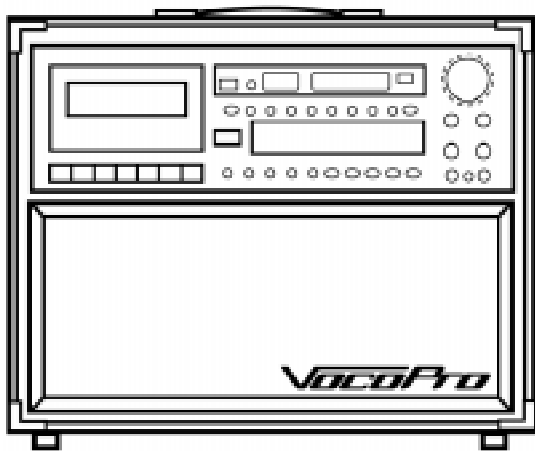

- 80W + 80W
- 19 STEP DIGITAL KEY CONTROLLER
- BUILT-IN CASSETTE PLAYER FOR PLAYBACK AND RECORDING
- BUILT-IN SHOCK RESISTANT CD/CDG PLAYER
- 2 MICROPHONE JACKS WITH INDIVIDUAL VOLUME CONTROLS
- KEY CONTROL JACK
- REMOTE CONTROL
- ECHO VOLUME CONTROL
- 3 AUDIO INPUTS WITH PRE-OUT AND RECORD-OUT
- TWO VIDEO INPUTS AND ONE VIDEO OUTPUT
- BASS AND TREBLE CONTROLS
- 110/220 SWITCHABLE
- PAL/NTSC SWITCHABLE
- DIMENSIONS (WxDxH): 17" x 15 1/2" x 6"

TABLE OF CONTENTS

Congratulations! And thank you for purchasing the VocoPro BRAVO. With proper care and handling, this unit will continue to provide you with years of Karaoke entertainment and fun for friends and family. Please read this manual carefully before getting started.

Table of Contents	1
Before You Start	2
Quick Start	3
Using Effects and Changing the Key	4
Using the Cassette Deck	5
Using the Cassette Deck (<i>Cont.</i>)	6
<i>listen to your recording...</i>	7
<i>Other Parts of the Bravo</i>	7
Connecting Other Components	8
Connecting Other Component (<i>Cont.</i>)	9
Care and Handling	10
Trouble Shooting Guide	11
Parts and Functions (front panel)	12 - 14
Parts and Functions (rear panel)	15
Parts and Functions (rear panel <i>cont.</i>)	16
Connection A Television Monitor (diagram)	17
Connection Diagram <i>for other components</i>	18
Specifications	19

BEFORE YOU START

Thank you for purchasing The Bravo. At VocoPro we care about product quality and customer satisfaction. We know The Bravo will provide years of quality enjoyment and reliable music entertainment for you when used properly.

PLEASE READ CAREFULLY BEFORE USING YOUR NEW BRAVO

Unpacking The Bravo

Carefully remove The Bravo from its carton before discarding the packaging materials. If it should become necessary to return the unit for any reason the original packaging materials are best suited for transporting the unit to minimize any potential damage.

BE SURE YOU HAVE THE PARTS AND COMPONENTS INCLUDED WITH THE BRAVO.

1 VocoPro Bravo CDG & Cassette
Karaoke Player

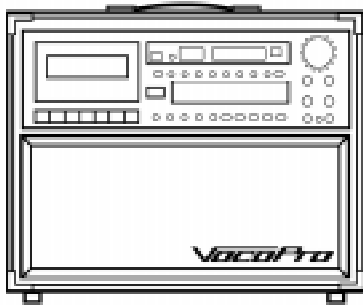

1 RCA cable for video hookup



SUPPLYING POWER TO THE BRAVO

IMPORTANT! Be sure all your components i.e., TV monitor, etc., are connected to the Bravo BEFORE connecting to a power source and supplying power to the unit. Be sure to use caution when plugging in any electrical appliance. The Bravo comes with its own standard wall outlet power cord. It is attached to the back of The Bravo player unit. Plug the power cord into any wall outlet or surge protector.

QUICK START

CONNECTING A TELEVISION MONITOR

If you will be connecting The Bravo to a television monitor use the RCA video connector wire that is included. On the back of the player, locate the RCA connector jack labeled "VIDEO OUTPUT", it is color coded in yellow. Connect either end of the RCA connector wire to the "VIDEO OUTPUT" jack and the other end to your television monitor. There should be an RCA connector jack, just like the one on the back of the player, labeled video input. Connecting this wire will enable your television monitor to display the graphics that are encoded on CDG Karaoke discs. **NOTE: If your television does not have an RCA type connector you may use the RF Modulator jack on the back of the Bravo.**

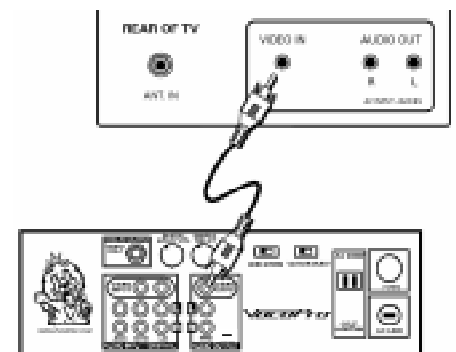

IMPORTANT! Before connecting a microphone, be sure the power is off or the volume is turned all the way down. When the microphone is plugged in and the unit is on do not point the microphone directly toward the speakers or leave an unattended microphone too close to the speakers when the volume is up. This can create a loud squeal called "feedback" and could possibly damage your speakers.

CONNECTING A MICROPHONE

1. Using a microphone cable, designed for use with most Karaoke products, connect a microphone to the end of the cable with the "XLR" connector (see diagram).
2. Connect the end of the cable with the 1/4" connector into either of the 1/4" jacks on the front of The Bravo amplifier player.

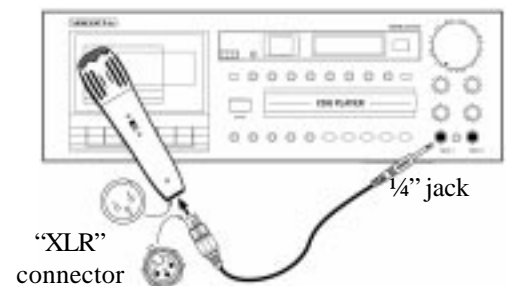

QUICK START

USING THE CDG PLAYER



TURN ON THE BRAVO

1. Locate the power switch on the front of The Bravo player. Press the power switch once to turn on the machine.
2. **Locate the “CDG” button below the CDG tray. This selects the mode you will use the player in.**
3. Carefully increase the volume by turning the large volume knob clockwise until the desired volume is reached.
4. Carefully increase the microphone volume (see “Parts and Functions” diagram #21) until desired volume is reached.

PLAYING CD/CDG’s

1. Locate the “OPEN/CLOSE” button on the front of The Bravo player.
2. Press once to open the CD tray. The tray will open automatically after the button is pressed.
3. Lay the CD/CDG on the open tray and press the “OPEN/CLOSE” button again. The tray will close automatically after the button is pushed. **IMPORTANT: DO NOT PUSH THE TRAY CLOSED MANUALLY, THIS COULD DAMAGE THE UNIT.**

STARTING THE CD PLAYER

1. Locate the “PLAY/PAUSE” button above the CD tray.
2. Press once to start the CD. Pressing the “PLAY/PAUSE” button will play song selection #1 on the CD/CDG disc. The song will automatically begin playing after a few seconds.

TO PLAY A DIFFERENT SELECTION

1. Locate the “NEXT” button above the CD tray. Press the button until the number of the desired song selection appears in the LCD display window. Note: You may hold down the button continually to advance the song selection or press consecutively. The song you stop on will automatically begin playing after a few seconds.

FAST FORWARD AND REVERSE

1. To advance your selection while it is playing, for example to the next verse or chorus, locate the “F-SCAN” key above the CDG player and press until you find the desired location.
2. To rewind your selection while it is playing, locate the “B-SCAN” key above the CDG player and press until you find the desired location. **PLEASE NOTE:** When using this feature the words may become jumbled on your TV monitor. In this scenario, digital graphics information does not process as rapidly as audio signals. Therefore the video signal will have to “catch up” to the audio signal. The screen will “refresh” on it’s own.

BALANCING YOUR MIX

1. It is best to begin by first setting the music volume at a comfortable level for the room in which you are using your Bravo. The number of people in a room will generally have an effect on the acoustics of a room and how much volume you will need.
2. Once the desired music volume is achieved, test each microphone volume individually by speaking or singing into the microphone, holding it approximately two inches away from your mouth.
3. Adjust the volume control(s) for each microphone until an equal mix of music and vocals can be heard. Remember to allow for vocal variances in each song where it may be necessary to sing louder or softer.

USING EFFECTS AND CHANGING THE KEY



ADDING BASS OR TREBLE TO THE MUSIC

1. Locate the small “BASS” and “TREBLE” control knobs on the front of The Bravo underneath the large “MUSIC VOL” knob.
2. To add bass tone to the music, turn the “BASS” knob clockwise until you have added the desired amount of bass tone to the music. Likewise to remove bass tone turn the knob counter clockwise.
3. To add treble tone to the music, turn the “TREBLE” knob clockwise until you have added the desired amount of treble tone to the music.

Note: A bass tone is a “low” “warm” tone. A treble tone is a “higher” and “brighter” sounding tone than a bass tone. How much is added or taken out is a matter of personal preference to the listener(s).

ADDING EFFECTS (DELAY/ECHO) TO THE VOCAL SIGNAL

1. The “ECHO” and “DELAY” control knobs are located on the back of The Bravo player. (See diagram below). Turn the knob in a clockwise motion until the desired amount of echo is achieved on the vocal signal. This is usually a preference by the singer. The more echo that is used the “thinner” the voice sounds.

CHANGING THE KEY OF THE MUSIC

Sometimes a singer would like to sing a particular song but will find it may not be written within a key or range comfortable for the singer. In this case you can raise or lower the pitch or key of the music to make it easier to sing, both on a CD/CDG or cassette. NOTE: When raising or lowering the key of the music the tempo will remain the same.

1. First locate the Key Control buttons on the front of the CDG-X3 Mark II player. You will find them below the “POWER” button on the face of the machine. (See diagram). There are three buttons under which are the words “KEY CONTROL”. There is a button for each of the following three functions.
 - a. Sharp \sharp Used to raise the pitch or key of the music.
 - b. Natural \natural Used to return the music to it’s “natural” or “original” pitch or key.
 - c. Flat \flat Used to lower the pitch or key of the music.

RAISING OR LOWERING THE PITCH (OR KEY) OF THE MUSIC

1. To raise the pitch or key of the music press the “sharp” (\sharp) sign once for each $\frac{1}{2}$ step you would like the music raised.
2. To lower the pitch or key of the music press the “flat” (\flat) sign once for each $\frac{1}{2}$ step you would like the music lowered.
3. To return the music to its “natural” or “original” key, simply press the “natural” key button once.

NOTE: The digital display will show how many half steps a song is raised or lowered by indicating a (+) or (-) before a number to indicate raised (+) or lowered (-). It will display (+0) if the current song selection is being played in the natural key.

USING THE CASSETTE DECK



IMPORTANT INFORMATION ABOUT RECORDING WITH THE BRAVO:

When recording with The Bravo, the bass and treble settings you use, will be recorded exactly as they are set while your are recording, so that you have more control over your recording. The important thing to remember is to **RESET THE CONTROLS TO A “FLAT” SETTING WHEN LISTENING BACK TO YOUR RECORDING ON THE BRAVO**, otherwise the bass and treble settings will sound doubled. In other words, when listening to your recording **ON THE BRAVO**, you will need to reduce the amount of bass and treble [but only] while listening, otherwise your recording **MAY** sound distorted. When playing the recording on another tape deck it should sound as it did when you recorded it.

USING THE CASSETTE DECK TO PLAY OR PLAYBACK

1. Locate the “CASSETTE” button under the CD tray on the front of the unit (See diagram) NOTE: When recording, this button should be set to “CDG”.
2. Press once to change to cassette mode for playing and recording cassette tapes.
3. Locate the “ST/EJ” button on the front of the cassette deck and press to open cassette door.
4. Insert the cassette tape with the side you want to play facing you and carefully close the cassette door, never force.
5. To rewind the cassette press the ”REW’ button until the tape rewinds to the desired location.
6. To advance the cassette press the “F-FWD” button until the tape advances to the desired location.
7. To stop either function locate the “STOP” button and press once. This will stop advancing, rewinding or playing the cassette tape.
8. To play the desire selection locate the “PLAY” button and press once.

NOTE: The graphics function will not work with cassette tapes.

CHANGING THE KEY OF THE MUSIC USING THE CASSETTE DECK

Follow the same instructions for changing the key or pitch with the cassette deck as for changing the key for the CD/CDG player.

See: RAISING OR LOWERING THE PITCH (OR KEY) OF THE MUSIC. (ABOVE)

USING THE CASSETTE DECK (Cont.)



TO RECORD WITH THE CASSETTE DECK

You can record your voice on the cassette deck while singing with a Karaoke CD/CDG.

1. **NOTE: Be sure to select the “CDG” button located under the CDG tray before you start.** Follow the instructions for playing a CD/CDG and select the desired “track” (song), but do not start your song selection yet. Press the “PLAY PAUSE” key until the word “PAUSE” appears in the display window.
2. Be sure the blank cassette tape is placed in the cassette deck and the cassette door closed.

TAPE COUNTER

3. Set the Tape counter to zero by pushing the “RESET” button located next to the “COUNTER” on the front of the unit. This will help you keep track of your place on the tape if you are recording multiple songs but not starting from the beginning of the tape.

Note: If you have rewound the cassette tape all the way to the beginning note that there are a few seconds of “leader” tape at each end of the cassette on which you can not record.

4. Locate the “REC” and “PLAY” keys of the cassette deck and press them simultaneously until they stay in the down position. Note: The “REC” key has a red line on the top instead of a white line.
5. View the advancing cassette through the cassette door window and let tape run until it has passed the “leader” tape. If it is not visible, allow approximately 10 seconds to let the tape “roll” then locate and press the “PAUSE” key. This will stop the cassette from advancing but it will still be in the “record” mode. Leave the “PAUSE” button pressed.
6. Begin your CD/CDG song selection making sure your volume and echo controls are adjusted to your liking.
7. At the same time, release the “PAUSE” key and the tape will start “rolling”. Your selection and voice is now being recorded.

Note: Be careful not to “thump” the microphone while holding it or while singing. This will create noise that will be noticeable on your recording. **Tip:** When recording be careful not to “pop” the microphone. This means when singing be aware of the “plosive” consonants like “P” and “T”. Excessive breath on these consonants will create an undesirable “pop” sound on your recording.

TO RECORD ANOTHER SONG

When you have finished recording you can record another selection without repeating step 3 in “TO RECORD WITH THE CASSETTE DECK” or “wasting” tape between songs.

1. When your song has finished recording press the “PAUSE” key on the cassette deck. This will stop the tape from recording but it will still be in record mode.
2. When you are ready to begin your next song selection release the “PAUSE” key and the tape will begin recording.
3. Press “ST/EJ” OR “PAUSE” when finished recording, depending on whether you want stop or record again.

listen to your recording...

OTHER PARTS OF THE BRAVO



TOLISTEN TO YOUR RECORDING

1. When you have finished recording stop the tape by pressing the “ST/EJ” key.
2. Rewind the tape by pressing the “REW” key until the tape stops at the desired location.
3. Select the “CASSETTE” button located below the CDG player to switch to cassette mode.
Note: This button should be set to CDG when recording from CDG to cassette.
4. Start the tape playback by pressing the “PLAY” key on the cassette deck.
5. Adjust the master volume control to the desired listening level. (See ”IMPORTANT INFORMATION” on page 5)

Reminder: If you set the tape counter to zero before you start recording you can more easily keep track of you location on the tape.

OTHER PARTS OF THE BRAVO

RFMODULATOR

To accommodate those televisions which do not have RCA connectors The Bravo is supplied with an RF modulator.

VOLTAGESELECT

This is used to select the voltage according to the country. In Europe select 220-224v, in USA select 110v.

VIDEO SYSTEM (NTSC/PAL)

This is used to select the video system according to country. In Europe select PAL, in USA select NTSC.

AC OUTLET

The AC outlet can be used to connect an additional component up to 200W maximum.

FUSE:

IMPORTANT! IF THE FUSE BLOWS OUT IT IS AN IMPORTANT INDICATION THERE MAY BE A SHORT SOMEWHERE IN THE SYSTEM. DO NOT REPLACE THE FUSE! TAKE YOUR BRAVO TO AN AUTHORIZED REPAIR FACILITY. REPLACING THE FUSE COULD POSSIBLY CAUSE ADDITIONAL DAMAGE THAT MAY NOT BE COVERED BY THE WARRANTY.



CONNECTING OTHER COMPONENTS TO THE BRAVO



The Bravo is designed so you can connect other components to it and use the Karaoke features that are built-in to the Bravo in conjunction with those components.

EXPANDING YOUR SYSTEM - USING THE BRAVO FEATURES WITH OTHER COMPONENTS

You may use the Karaoke features (echo, delay, key changer) that are built into the Bravo with other components just by connecting the components as described in this section. The Karaoke features will automatically be functional when additional components are properly connected. (Also see REAR PANEL PARTS AND FUNCTIONS for additional connection information)

CONNECTING AN AMPLIFIER (for sound)

An amplifier can be connected to the Bravo through the “L” and “R” “**PRE**” OUTPUT jacks located in the back of the Bravo (See manufacturer’s instructions with your amplifier)

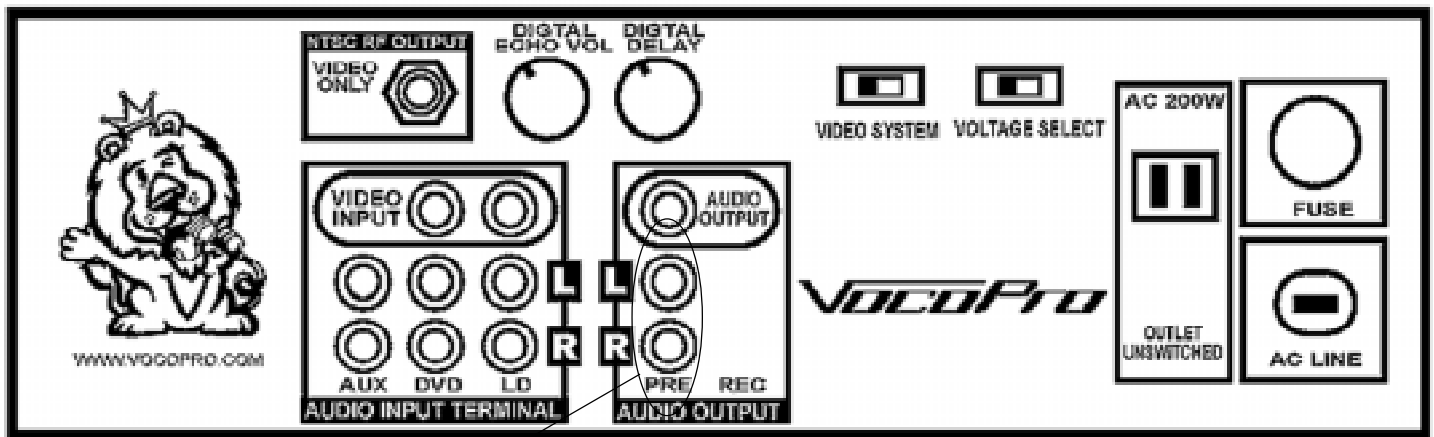

“L” and “R” “**PRE**” OUTPUT jacks

CONNECTING A DVD PLAYER OR MINI-DISC PLAYER

Using an RCA connector cable, connect the “L” and “R” “DVD” INPUT jacks to the “L” and “R” “AUDIO OUTPUT” jacks on the DVD player (check manufacturer’s instructions). **BE SURE TO SET THE INPUT SELECTOR ON THE FRONT OF THE BRAVO TO “DVD”, OTHERWISE THERE WILL BE NO SOUND.** Play the DVD player as usual. Music from the DVD player will be audible from your speakers and the Karaoke features will be functional.

CONNECTING OTHER COMPONENTS TO THE BRAVO



CONNECTING A LASER DISC PLAYER

Using an RCA connector cable, connect the “L” and “R” “LD” INPUT jacks to the “L” and “R” “AUDIO OUTPUT” jacks on the LD player (check manufacturer’s instructions). BE SURE TO SET THE INPUT SELECTOR ON THE FRONT OF THE BRAVO TO “LD”, OTHERWISE THERE WILL BE NO SOUND. Play the LD player as usual. Music from the LD player will be audible from your speakers and the Karaoke features will be functional.

CONNECTING AN ADDITIONAL TAPE DECK TO PLAY OR RECORD ON THE BRAVO

TO PLAY MUSIC FROM AN ADDITIONAL TAPE DECK THROUGH THE BRAVO: Using an RCA connector cable, connect the “L” and “R” “AUX” INPUT jacks on the Bravo to the “L” and “R” “AUDIO OUTPUT OR PLAY OUT” jacks on the tape deck (check manufacturer’s instructions). BE SURE TO SET THE INPUT SELECTOR ON THE FRONT OF THE BRAVO TO “AUX”, OTHERWISE THERE WILL BE NO SOUND. Play the tape deck as usual. Music from the tape deck will be audible from your speakers. All the Karaoke features will be functional except video. **TO RECORD TO THE BRAVO FROM AN ADDITIONAL TAPE DECK:** To record music from the additional tape deck to the Bravo tape deck, play the additional tape deck and follow the directions for recording on the Bravo tape deck under “USING THE CASSETTE DECK, To Record With The Cassette Deck”.

CONNECTING AN ADDITIONAL RECORDING DEVICE TO RECORD FROM THE BRAVO (Tape Deck, Mini Disc or DAT)

TO RECORD MUSIC ONLY FROM THE BRAVO ONTO AN ADDITIONAL RECORDING DEVICE: Using an RCA connector cable, connect the “L” and “R” “REC” OUTPUT jacks on the Bravo to the “L” and “R” “AUDIO INPUT OR REC IN” jacks on the recording device (Check manufacturer’s instructions). BE SURE TO SET THE INPUT SELECTOR ON THE FRONT OF THE BRAVO TO WHICHEVER PLAYER YOU ARE USING, OTHERWISE THERE WILL BE NO SOUND. Set up your additional recording device to record then play your selection. The Karaoke features will be functional from the BRAVO. Music ONLY will be recorded onto the additional tape deck.

TO RECORD MUSIC AND VOCALS FROM THE BRAVO ONTO AN ADDITIONAL RECORDING DEVICE: Using an RCA connector cable, connect the “L” and “R” “PRE” OUTPUT jacks on the Bravo to the “L” and “R” “AUDIO INPUT OR REC IN” jacks on the recording device (check manufacturer’s instructions). BE SURE TO SET THE INPUT SELECTOR ON THE FRONT OF THE BRAVO TO WHICHEVER PLAYER YOU ARE USING, OTHERWISE THERE WILL BE NO SOUND. Set up your additional recording device to record then play your selection. The Karaoke features will be functional from the BRAVO. Music AND vocals will be recorded onto the additional recording device.

CONNECTING THE BRAVO TO YOUR HOME STEREO

TO PLAY MUSIC FROM THE BRAVO ON YOUR HOME STEREO: Using an RCA connector cable, connect the “L” and “R” “PRE” OUTPUT jacks on the Bravo to any of the “L” and “R” “AUDIO INPUT” channels i.e., “CD” or “AUX” on your stereo. DO NOT CONNECT TO THE PHONO JACKS. (Check manufacturer’s instructions). BE SURE TO SET THE INPUT SELECTOR ON YOUR STEREO TO THE CORRESPONDING INPUT JACKS YOU HAVE SELECTED TO CONNECT THE BRAVO, OTHERWISE THERE WILL BE NO SOUND. Play the Bravo as usual. Music from the Bravo will be audible from the stereo speakers. All the Karaoke features will be functional.

CARE AND HANDLING

- ① Wipe the Bravo with a clean damp (not wet) cloth to remove dust. Do not use solvents or other cleaning agents as this may harm the finish. To remove dust from the cloth speaker cover try using the brush upholstery attachment of any household vacuum cleaner, and vacuum the dust from the screen.
- ② Do not set food or liquids on the Bravo, to avoid potential electrical shortages, or spilling anything into the electronics, working parts, or speakers, that may cause damage not covered by your warranty.
- ③ Do not use near excessive heat sources, such as wall radiators, or near water sources to avoid the risk damage to the unit or electrical shock.
- ④ Do not transport the unit with discs or tapes inside the player.
- ⑤ Turn off machine before unplugging the unit from wall outlet. Never pull the power cord to unplug. For safety, always use the plug.

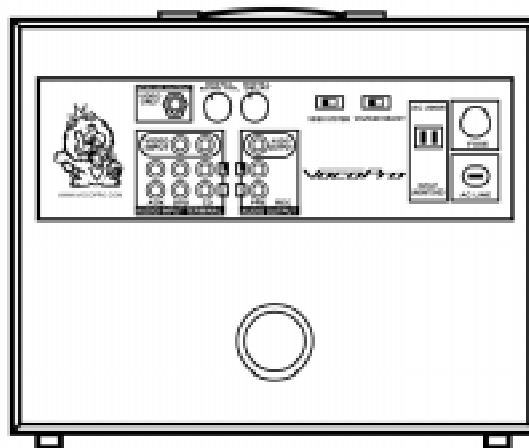
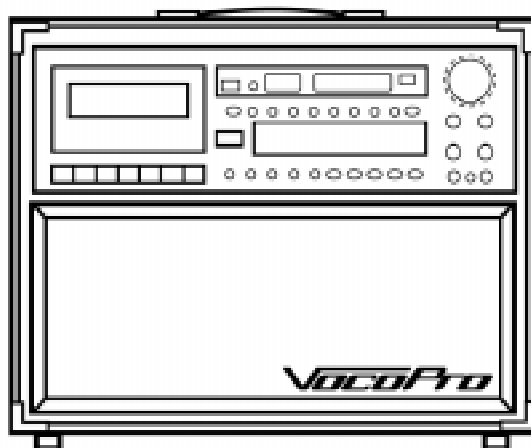

VocoPro
ULTIMATE CHOICE OF KARAOKE ENTERTAINMENT

TROUBLE SHOOTING GUIDE



PROBLEM	POSSIBLE CAUSE(S)	SOLUTION(S)
<p>No video signal. Words don't appear on the TV monitor.</p>	<p>The television may not be switched to the proper video input channel.</p>	<p>Be sure the television is set to the "VIDEO" mode (see your television's owners manual).</p> <p>Be sure the "VIDEO OUTPUT" jack (See PARTS AND FUNCTIONS diagram) on the rear panel of the Bravo is connected to the "VIDEO INPUT" section of the TV monitor.</p>
<p>Unable to connect the Bravo to my television monitor with the "RCA" cable provided.</p>	<p>Not all televisions/monitors have "RCA" connector jacks.</p>	<p>The Bravo has a built-in "RF Modulator" B jack for those TV's without RCA jacks. (Also see PARTS AND FUNCTIONS, #17 and diagram for "CONNECTING A TELEVISION MONITOR ". There are three options for connecting televisions without video input jacks.</p>
<p>There is a loud "squealing" noise coming from speakers.</p>	<p>This noise is called "feedback". Feedback occurs for various reasons. For example, feedback can occur if the microphone is held too closely to, or pointed directly at, the speakers . Feedback can also occur if the microphone volume is too high or there is too much treble frequency being used.</p>	<p>Turn down the microphone volume.</p> <p>Turn down the treble control.</p> <p>Hold the microphone away from the speakers.</p>
<p>Noisy or loud playback from tape recorded on the Bravo.</p>	<p>The Bravo records the bass and treble settings exactly as you hear them. Therefore when the recorded audio tape is played back on the Bravo the bass and treble will sound doubled.</p>	<p>Lower the bass and treble settings when listening back to your recorded tape on the Bravo. Adjust the sound accordingly until you achieve the desired result.</p>

PARTS AND FUNCTIONS

(FRONT PANEL)

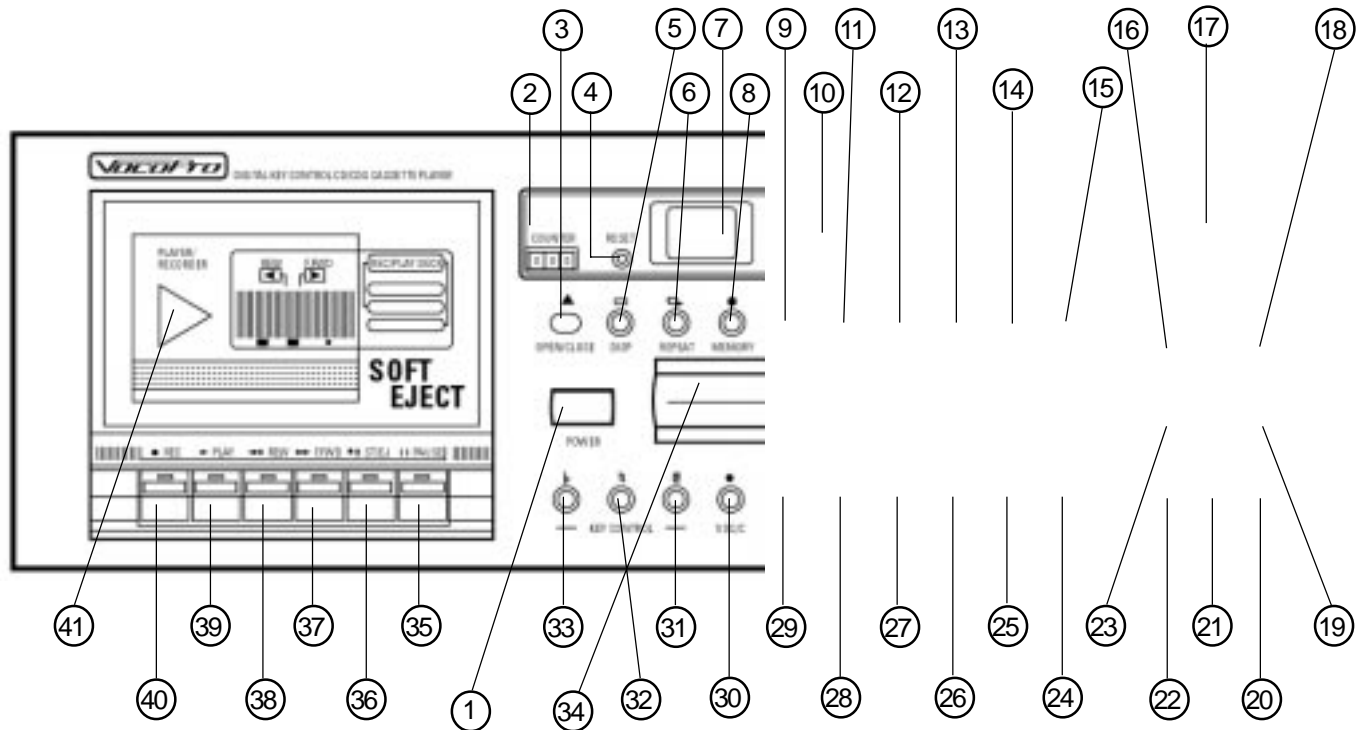

- ① **POWER BUTTON:** Turns on the power to the BRAVO.
- ② **TAPE COUNTER:** Use the tape counter when playing or recording cassettes to keep track of your location on the tape.
- ③ **OPEN/CLOSE BUTTON:** To open/close CD/CDG tray.
- ④ **RESET BUTTON:** Push the reset button to reset the tape counter to zero when using the cassette deck.
- ⑤ **DISPLAY BUTTON:** When playing a CD/CDG disc and pressed once this button displays the remaining number of songs to play on the disc, and time remaining in minutes and seconds to play them, in the CDG Display Window (#10). This feature works only with the CD/CDG player. When pressed again the window displays the song selection number and the elapsed time in minutes and seconds.
- ⑥ **REPEAT BUTTON:** When using the CD/CGD player and pressed **once**, this feature allows the user to repeat the current song selection. When pressed **twice** all the songs on the disc will repeat once each. Songs will repeat until the button is pressed a third time. The display window will show which function you have selected, "REPEAT" (repeats current song selection) or "ALL" (repeats all songs).
- ⑦ **KEY CONTROL DISPLAY:** Displays the number of half-steps up (+) or down (-) you have chosen. When the display reads zero "0" you are in the song's "natural" key.
- ⑧ **MEMORY BUTTON:** The memory function is used to program specific song selections in any order. First, you'll need to clear the memory. If there is a CD/CDG in the player press stop. Press the "OPEN/CLOSE" button once until the tray opens and again to close it. Doing this will clear out any previously stored program(s) from the memory. Next, press the "MEMORY" button once. There will be a "P:01" with the word "PROGRAM" above it and two dashes (- -) to the left, shown in the display window. Press the "NEXT" button the desired amount of times to display the song selection number you wish to program first in your program order. The song selection number will be displayed where the two dashes were (- -). Proceed to program the next song selection by pressing the "MEMORY" button again. Doing so will store your first song selection and display a "P:02" and two dashes (- -) to the left. Repeat the process as above to program up to twenty song selections. When finished, press "PLAY/PAUSE" to begin playing your selections. The program order will be stored until the "OPEN/CLOSE" button is pressed again.
- ⑨ **PREVIOUS SELECTION BUTTON:** Press this button to select the previous song on the CDG disc being played. Press once for each song you want to skip back to, or hold the button down to skip back continually. The selection number will be displayed in the display window (#10).
- ⑩ **CDG DISPLAY WINDOW:** This window displays the current song selection playing on the CDG disc.

PARTS AND FUNCTIONS



(FRONT PANEL CONT.)



- ⑪ **NEXT SELECTION CONTROL BUTTON:** Press this button to advance the CDG to the next song selection. Press once for each song you want to advance to, or hold the button down to advance continually. The selection number will be displayed in the display window (#10).
- ⑫ **B-SCAN:** Press this button to “scan” the song selection in reverse. This feature works the same as the “rewind” key on a cassette deck. The difference between this feature and the “PREV” selection control button is this feature reverses the CDG within the song selection and the “PREV” button skips back to the previous song.
- ⑬ **F-SCAN:** Press this button to forward “scan” the song selection. This feature works the same as the “fast-forward” key on a cassette deck. The difference between this feature and the “NEXT” selection control button is this feature advances the CDG within the song selection and the “NEXT” button skips forward to the next song.
- ⑭ **STOP:** This button stops the CDG disc from playing.
- ⑮ **PLAY/PAUSE:** Use this button to start playing the song selection and/or to pause the selection at any time during play. Press once to play, press again to pause. If paused, press once to resume playing song selection.
- ⑯ **BASS CONTROL:** This controls the amount of bass tone in the **music** being played. (See “Using Effects”)
- ⑰ **MUSIC VOLUME:** This controls the volume of the **music** being played.
- ⑱ **TREBLE CONTROL:** This controls the amount of treble tone in the **music** being played. (See “Using Effects”)
- ⑲ **MIC VOLUME 2:** This controls the volume for the 2nd microphone input.
- ⑳ **MIC 2:** Microphone input jack for a 2nd microphone.
- ㉑ **KEY CONT.:** This is used to connect the optional “key control” microphone. (Not included)
- ㉒ **MIC 1:** Microphone input jack.
- ㉓ **MIC VOLUME 1:** This controls the volume for the microphone input.
- ㉔ **AUX:** Auxiliary input selector key. Pressing this key will select the component that is connected to the auxiliary input. For example, if an additional tape deck or CD player is used with the **Bravo**, and it is connected to the “AUX” input jacks, this key will need to be selected before the component can be used.
- ㉕ **DVD:** Digital video disc input selector key. Pressing this key will select the component that is connected to the DVD input jacks. For example, if a DVD player is used with the **Bravo** and it is connected to the “DVD” input jacks, this key will need to be selected before the component can be used.
- ㉖ **LD:** Laser disc input selector key. Pressing this key will select the component that is connected to the “LD” input jacks. For example, if a DVD player is used with the **Bravo**, and it is properly connected to the “LD” input jacks, this key will need to be selected before the component can be used.
- ㉗ **CDG:** CDG selector key. This key must be pressed when playing a CD or CDG disc in the **Bravo**. NOTE: This key must be pressed if you are recording from the CDG player in the **Bravo** onto the cassette deck otherwise you will not be able to hear the CDG disc that is playing.
- ㉘ **CASSETTE:** Cassette selector key. This key must be pressed when playing a cassette in the **Bravo** cassette deck. NOTE: DO NOT press the cassette key if you are recording from the CDG player in the **Bravo** onto the cassette deck, otherwise you will not be able to hear the CDG disc that is being played. (The “CDG” key must be pressed when recording from the CDG player to the cassette deck.
- ㉙ **VOC/P:** Vocal Partner key. This feature is designed to work only with “multiplex” Karaoke discs. By pressing this key the “guide” or “lead” vocal on the multiplex disc will be removed **when you are singing**. When you stop singing the “guide/lead” vocal will **again become audible**, so it’s like having a “vocal partner”. For example, if you want to sing every other verse in a song you may do so when using this feature. The “guide/lead” vocal will automatically begin a second after you stop singing and become inaudible when you resume singing until the VOC/P key is pressed again.
- ㉚ **VOC/C:** Vocal Cancel key. This feature is designed to work only with “multiplex” Karaoke discs. By pressing this key the “guide” or “lead” vocal on the multiplex disc will be removed throughout the entire song. To hear the guide/lead vocal press the key again.

PARTS AND FUNCTIONS

(FRONT PANEL CONT.)

- ▶ ▶ ▶ ▶ ▶ ▶ ▶ ▶ ▶ ▶ ▶
- 31 **SHARP KEY:**  Press this key to RAISE the pitch of the song selection being played. This feature raises the pitch of the song one half-step for each time it is pressed, up to nine half-steps. The sharp key is part of the “key control” feature and will work with the CDG player and cassette deck. The key control feature will also work with external players when properly connected to the **Bravo**. (See “Using Effects and Changing the Key” and “Connecting Other Components to the Twister”) **Note: The key control feature will not change the tempo of the song being played.**
- 32 **NATURAL KEY:**  Press the natural key once to RETURN the pitch of the song selection being played to its “natural key” or pitch. The natural key is part of the “key control” feature and will work with the CDG player and cassette deck. The key control feature will also work with external players when properly connected. (See “Using Effects and Changing the Key” and “Connecting Other Components to the Bravo”) **Note: The key control feature will not change the tempo of the song being played.**
- 33 **FLAT KEY:**  Press this key to LOWER the pitch of the song selection being played. This feature lowers the pitch of the song one half-step for each time it is pressed, to as many as nine half-steps. The flat key is part of the “key control” feature and will work with the CDG player and cassette deck. The key control feature will also work with external players when properly connected to the **Bravo**. (See “Using Effects and Changing the Key” and Connecting Other Components to the **Bravo**) **Note: The key control feature will not change the tempo of the song being played.**
- 34 **CD/CDG TRAY:** Press the “OPEN/CLOSE” button (See #3 on diagram) to open the CD/CDG tray. Carefully set your CD/CDG disc onto the tray and press the OPEN/CLOSE button again to close tray. Never push or force tray closed manually.
- 38 **REW:** “REWIND” When playing a cassette, this key can be used to rewind the cassette to the previous location. To advance the tape, press the “ST/EJ” (STOP) key first to stop the tape, then press “F-FWD”.
- 39 **PLAY:** After a cassette tape has been inserted into the cassette player, press this key to begin playing. When recording, press this key together with the “REC” (RECORD) key to begin recording. (See “USING THE CASSETTE DECK”, “To Record With The Cassette Deck”)
- 40 **REC:** “RECORD” To record press the “PLAY” key and the “REC” key together and the cassette will begin recording. For detailed instructions: (See “USING THE CASSETTE DECK” under “To Record With The Cassette Deck”)
- 41 **CASSETTE DOOR:** This compartment holds a cassette tape for playing or recording. To open the cassette door, press “ST/EJ” (STOP/EJECT). After inserting or removing a cassette tape **gently** push the cassette door closed. **Never force the door closed.**

CASSETTE DECK PARTS AND FUNCTIONS

- 35 **PAUSE:** Press the “PAUSE” key once to momentarily stop the cassette tape from playing or recording. Press again to continue playing or recording.
- 36 **ST/EJ:** “STOP/EJECT” Press this key once to stop a cassette from playing or recording, press again to eject. When the cassette door opens insert or remove a tape.
- 37 **F-FWD:** “FAST FORWARD” When playing a cassette, this key can be used to advance the cassette to the next desired location. To advance the tape, press the “ST/EJ” (STOP) key first to stop the tape, then press “F-FWD”.



VocoPro
ULTIMATE CHOICE OF KARAOKE ENTERTAINMENT

PARTS AND FUNCTIONS (REAR PANEL)

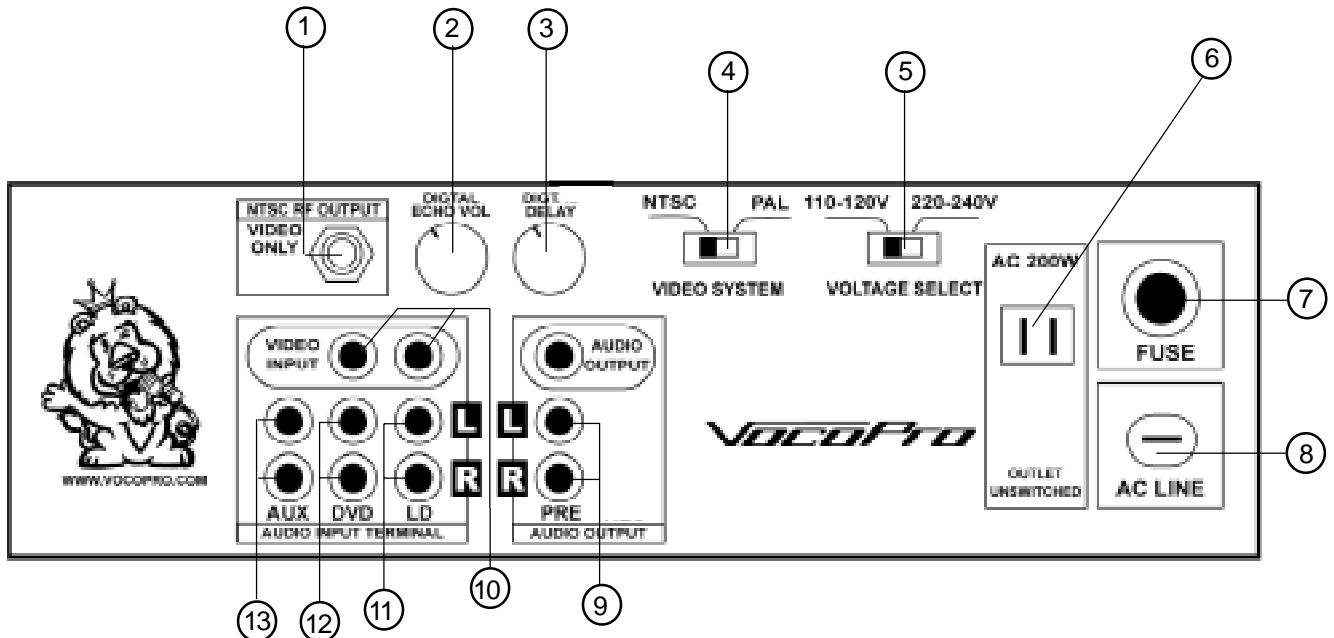

PARTS AND FUNCTIONS REAR PANEL

- ① **RF MODULATOR:** To accommodate those televisions which do not have RCA jacks, The Bravo is supplied with an RF Modulator in order to use the video feature.. (See #1, of the "REAR PANEL" diagram).
- ② **DIGITAL ECHO VOLUME FOR MIC-1 AND MIC-2:** This controls the amount ECHO microphones 1 and 2 will receive. Turn clockwise to increase echo and counterclockwise to decrease echo. (See "USING EFFECTS AND CHANGING THE KEY", Adding Effects (Delay/Echo) To The Vocal Signal)
- ③ **DIGITAL DELAY FOR MIC-1 AND MIC-2:** This controls the amount DELAY microphones 1 and 2 will receive. Turn clockwise to increase echo and counterclockwise to decrease echo. (See "USING EFFECTS AND CHANGING THE KEY", Adding Effects (Delay/Echo) To The Vocal Signal)
- ④ **NTSC/PAL SELECTOR SWITCH:** This switch is used to select the NTSC/PAL setting according to country. For US televisions systems it should be set to NTSC and for European television systems the selector should be set to PAL.
- ⑤ **VOLTAGE SELECTOR SWITCH:** This switch is used to select the voltage setting according to country. For use in the U.S., the voltage selector should be set to 110v-120v and 220v-240v in Europe.
- ⑥ **200W AC OUTLET:** This outlet can be used to connect another component providing it does not exceed 200 watts maximum power consumption.
- ⑦ **FUSE: IMPORTANT!** If the fuse blows out it's an indication that there may be a short in the system. **DO NOT REPLACE THE FUSE!** Doing so could possibly cause additional damage to the unit. **Take your Bravo to an authorized repair facility.**
- ⑧ **AC POWER CORD:** Plugs into any AC wall outlet.



PARTS AND FUNCTIONS

(REAR PANEL CONT.)



- 9 **LEFT AND RIGHT CHANNEL “PRE” OUTPUT JACKS:** These two output jacks can be used to connect an external tape deck **on which to record music AND vocals**, being played on the **Bravo**. Connect the left “L” and right “R” “PRE” output jacks of the **Bravo** to the respective left “L” and right “R” **input** jacks (usually “REC IN” on most tape decks) on the back of your external tape deck. (Follow instructions for using either player on the **Bravo**) Play the desired CD/CDG or cassette on the **Bravo** and record it on your external tape deck.
- 10 **VIDEO OUTPUT JACK:** The video output jack is used to connect the **Bravo** to a television monitor. When properly connected, the television monitor will display lyrics and graphics from CDG discs being played on the **Bravo**. There are three ways to connect a television monitor to the **Bravo**. **1)** Connect the “VIDEO OUTPUT” jack to the “VIDEO IN” on the back of the television monitor. There is an RCA connector cord provided with the **Bravo** for this type of connection. **BE SURE TO SWITCH YOUR TELEVISION MONITOR TO “VIDEO” MODE, OTHERWISE LYRICS AND GRAPHICS WILL NOT APPEAR.** **2)** If your television monitor does not have an RCA type connector and only has a coaxial connector, you can use the built-in RF Modulator on the back of the **Bravo**. (See diagram on opposite page). **3) For PAL TV systems without video inputs:** Connect The **Bravo** to an RF Modulator through the video output jacks on the **Bravo**. (See diagram on opposite page.)
- 11 **VIDEO INPUT JACKS:** There are two video **input** jacks on the back of the **Bravo**. They both serve the same purpose and can be used to connect two external players at a time. They are labeled separately, “DVD” (digital video disc) and “LD” (laser disc), to allow you to easily identify which jack you have connected to which player. When a DVD or LD player has been properly connected, (See “CONNECTING OTHER COMPONENTS TO THE BRAVO”), the television monitor connected to the **Bravo** will display lyrics and graphics from the discs being played on the external player(s). To connect an external player use an RCA connector cable. Connect either the DVD or LD VIDEO INPUT jack on the back of the **Bravo** to the “VIDEO OUTPUT” jack on the external respective player. The basic rule is “INPUT” connected to “OUTPUT”. **WHEN PLAYING AND EXTERNAL DVD OR LD PLAYER, BE SURE TO SELECT THE DVD OR LD SETTING ON THE FRONT OF THE BRAVO, OTHERWISE THERE WILL BE NO AUDIO OR VIDEO.** (See FRONT PANEL diagram, #26, #27)
- 12 **RIGHT AND LEFT AUDIO INPUT JACKS TO CONNECT EXTERNAL LASER DISC (LD) PLAYER:** The “R” and “L” “AUDIO INPUT” jacks are used to connect an external laser disc player to the **Bravo**. When properly connected, the **Bravo** will play the music being played on the laser disc player through the **Bravo** speakers. Connect the “R” and “L” “AUDIO INPUT” jacks on the **Bravo** to the “L” and “R” “AUDIO OUTPUT” jacks on the laser disc player, using an RCA type connector cable. **WHEN PLAYING AND EXTERNAL LD PLAYER, BE SURE TO SELECT LD SETTING ON THE FRONT OF THE BRAVO, OTHERWISE THERE WILL BE NO AUDIO OR VIDEO.**
- 13 **RIGHT AND LEFT AUDIO INPUT JACKS TO CONNECT AN EXTERNAL DIGITAL VIDEO DISC (DVD) PLAYER:** The “R” and “L” “AUDIO INPUT” jacks are used to connect an external laser disc player to the **Bravo**. When properly connected, the **Bravo** will play the music being played on the laser disc player through the **Bravo** speakers. Connect the “R” and “L” “AUDIO INPUT” jacks on the **Bravo** to the “L” and “R” “AUDIO OUTPUT” jacks on the laser disc player, using an RCA type connector cable. **WHEN PLAYING AND EXTERNAL LD PLAYER, BE SURE TO SELECT LD SETTING ON THE FRONT OF THE BRAVO, OTHERWISE THERE WILL BE NO AUDIO OR VIDEO.**



CONNECTING A TELEVISION MONITOR



3 Ways To Hook-Up Video To Your T.V.

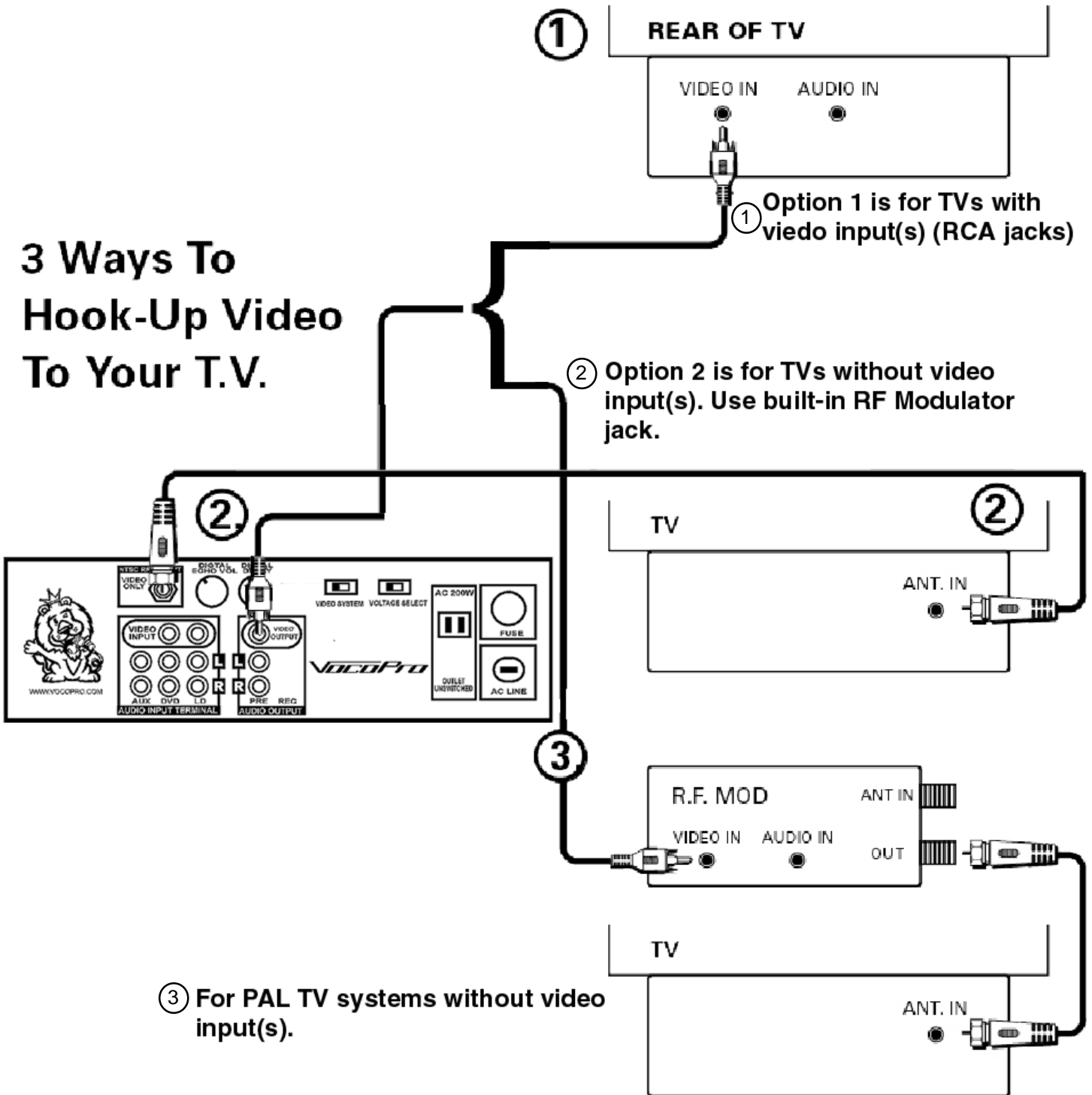

CONNECTION DIAGRAM

for other components

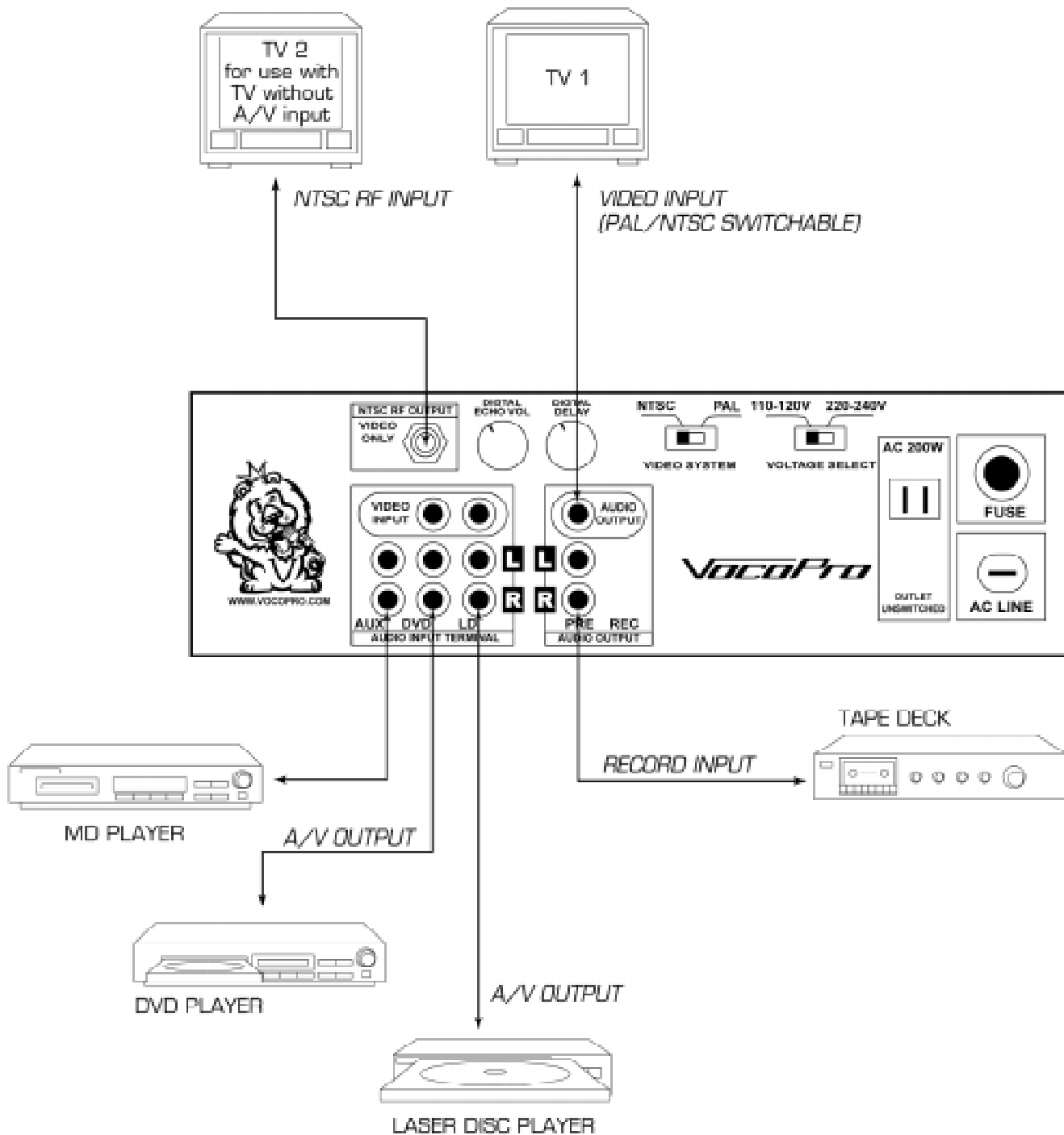

SPECIFICATIONS



Power Output	80W + 80W MAX. 40W + 40W RMS
Audio	
Microphone	2.5MV/10K Ohms
AUX/LD/DVD/CDG/Tape.....	50MV/50K Ohms
Video	
LD/DVD.....	1P-P/75 Ohms
Frequency Response	
AUX/LD/DVD/CDG/Tape.....	25Hz~20KHz± 3db
Tone Control (Music)	
Bass	+ 9dB (100Hz) + 2dB
Treble	+ 9dB (100KHz) + 2dB
Echo Delay Time	100 MSEC - 200 MSEC
Key Control Range	+9/-9 music intervals 19 (Position)
Signal to Noise	>50dB
Cross Talk	>40dB
RF Output Ch. 3 (Video Only)	
Power Supply Others	
Power Requirements	AC117V/230V 50Hz/60Hz
Power Consumption	130 Watt
AC Outlet	
Unswitched	1 (Total) 250W
Dimensions	(WxDxH): 470 x 425 x 591m/m



VOCOPro

ULTIMATE CHOICE OF KARAOKE ENTERTAINMENT