

VocoPro[®]

THE SINGER'S ULTIMATE CHOICE[™]

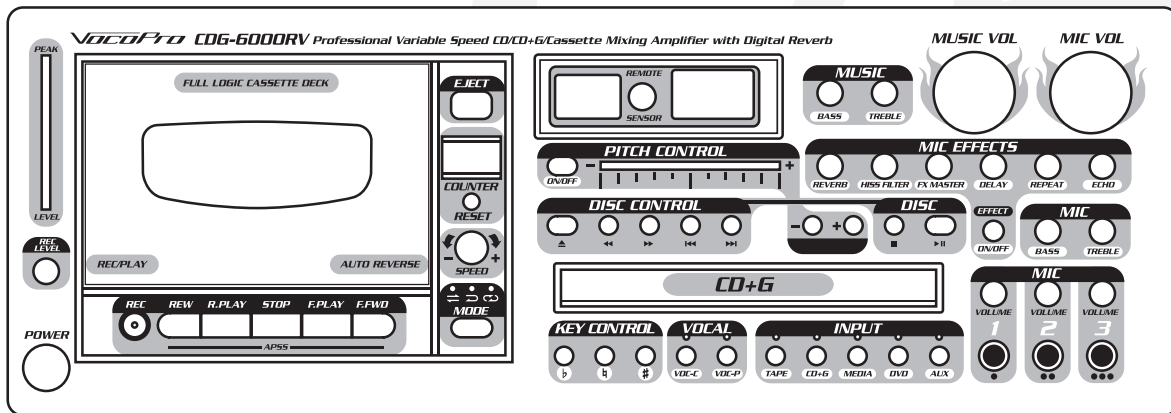
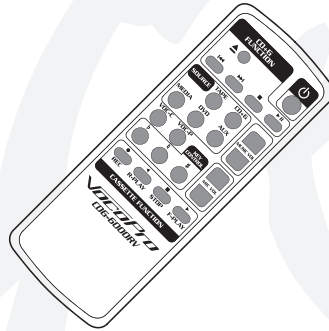

CDG-6000RV

Professional Variable Speed CD/CD+G/Cassette
Mixing Amplifier with Digital Reverb

o w n e r ' s m a n u a l

Table of Contents

Introduction

Safety Instructions	2-3
Welcome.....	4
Listening for a Lifetime	5
Before Getting Started	6
CDG-6000RV Features.....	7

Getting Connected

Connecting Input Source Players	8
Connecting TV's/Monitors	9
Connecting an External Effects Device	10
Connecting Speakers.....	11

Descriptions and Functions

Front Panel.....	12-13
Cassette Deck.....	14
Rear Panel	15
Remote Control	16
Cassete Deck Recording.....	19
Specifications	20
Troubleshooting.....	21



VocoPro[®]
THE SINGER'S ULTIMATE CHOICE[™]

Safety Instructions



CAUTION

RISK OF SHOCK



CAUTION: To reduce the risk of electric shock, do not remove cover (or back). No user-serviceable parts inside. Only refer servicing to qualified service personnel.

Explanation of Graphical Symbols



The lightning flash & arrowhead symbol, within an equilateral triangle, is intended to alert you to the presence of danger.



The exclamation point within an equilateral triangle is intended to alert you to the presence of important operating and servicing instructions.

WARNING

To reduce the risk of fire or electric shock, do not expose this unit to rain or moisture.

1. Read Instructions - All the safety and operating instructions should be read before the appliance is operated.

2. Retain Instructions - The safety and operating instructions should be retained for future reference.

3. Heed Warnings - All warnings on the appliance and in the operating instructions should be adhered to.

4. Follow Instructions - All operating and use instructions should be followed.

5. Attachments - Do not use attachments not recommended by the product manufacturer as they may cause hazards.

6. Water and Moisture - Do not use this unit near water. For example, near a bathtub or in a wet basement and the like.

7. Carts and Stands - The appliance should be used only with a cart or stand that is recommended by the manufacturer.

7 A. An appliance and cart combination should be moved with care. Quick stops, excessive force, and uneven surfaces may cause an overturn.



8. Ventilation - The appliance should be situated so its location does not interfere with its proper ventilation. For example, the appliance should not be situated on a bed, sofa, rug, or similar surface that may block the ventilation slots.

9. Heat - The appliance should be situated away from heat sources such as radiators, heat registers, stoves, or other appliances (including amplifiers) that produce heat.

10. Power Sources - The appliance should be connected to a power supply only of the type described in the operating instructions or as marked on the appliance.

11. Grounding or Polarization - Precautions should be taken so that the grounding or polarization means of an appliance is not defeated.

12. Power-Cord Protection - Power-supply cords should be routed so that they are not likely to be walked on or pinched by items placed upon or against them, paying particular attention to cords at plugs, convenience receptacles, and the point where they exit from the appliance.

13. Cleaning - Unplug this unit from the wall outlet before cleaning. Do not use liquid cleaners or aerosol cleaners. Use a damp cloth for cleaning.

14. Power lines - An outdoor antenna should be located away from power lines.

15. Nonuse Periods - The power cord of the appliance should be unplugged from the outlet when left unused for a long period of time.

16. Object and Liquid Entry - Care should be taken so that objects do not fall and liquids are not spilled into the enclosure through openings.

17. Damage Requiring Service - The appliance should be serviced by qualified service personnel when:

- A. The power supply cord or plug has been damaged; or
- B. Objects have fallen into the appliance; or
- C. The appliance has been exposed to rain; or
- D. The appliance does not appear to operate normally or exhibits a marked change in performance; or
- E. The appliance has been dropped, or the enclosure damaged.

18. Servicing - The user should not attempt to service the appliance beyond that described in the operating instructions. All other servicing should be referred to qualified service personnel.

Note:

To CATV system installer's (U.S.A.): This reminder is provided to call the CATV system installer's attention to Article 820-40 of the NEC that provides guidelines for proper grounding and, in particular, specifies that the cable ground shall be connected as close to the point of cable entry as practical.

FCC INFORMATION (U.S.A.)

1. IMPORTANT NOTICE: DO NOT MODIFY THIS

UNIT!: This product, when installed as indicated in the instructions contained in this manual, meets FCC requirements. Modifications not expressly approved by Vocopro may void your authority, granted by the FCC, to use this product.

2. IMPORTANT: When connecting this product to accessories and/or another product use only high quality shielded cables. Cable(s) supplied with this product **MUST** be used. Follow all installation instructions. Failure to follow instructions could void your FCC authorization to use this product in the U.S.A.

3. NOTE: This product has been tested and found to comply with the requirements listed in FCC Regulations, Part 15 for Class "B" digital devices. Compliance with these requirements provides a reasonable level of assurances that your use of this product in a residential environment will not result in harmful interference with other electronic devices. This equipment generates/uses radio frequencies and, if not installed and used according to the instructions found in the owner's manual, may cause interference harmful to the operation of other electronic devices. Compliance with FCC regulations does not guarantee that interference will not occur in all installations. If this product is found to be the source of interference, which can be determined by turning the unit "Off" and "On", please try to eliminate the problem by using one of the following measures:

Relocate either this product or the device that is being affected by the interference.

Use power outlets that are on different branch (circuit breaker or fuse) circuits or install AC line filter(s).

In the case of radio or TV interference, relocate/reorient the antenna. If the antenna lead-in is 300-ohm ribbon lead, change the lead-in to coaxial type cable.

If these corrective measures do not produce satisfactory results, please contact your local retailer authorized to distribute Vocopro products. If you can not locate the appropriate retailer, please contact Vocopro, 1728 Curtiss Court, La Verne, CA 91750.

CAUTION

The apparatus is not disconnected from the AC power source so long as it is connected to the wall outlet, even if the apparatus itself is turned off. To fully insure that the apparatus is indeed fully void of residual power, leave unit disconnected from the AC outlet for at least fifteen seconds.

CAUTION:

READ THIS BEFORE OPERATING YOUR UNIT

1. To ensure the finest performance, please read this manual carefully. Keep it in a safe place for future reference.
2. Install your unit in a cool, dry, clean place - away from windows, heat sources, and too much vibration, dust, moisture or cold. Avoid sources of hum (transformers, v motors). To prevent fire or electrical shock, do not expose to rain and water.
3. Do not operate the unit upside-down.
4. Never open the cabinet. If a foreign object drops into the set, contact your dealer.
5. Place the unit in a location with adequate air circulation. Do not interfere with its proper ventilation; this will cause the internal temperature to rise and may result in a failure.
6. Do not use force on switches, knobs or cords. When moving the unit, first turn the unit off. Then gently disconnect the power plug and the cords connecting to other equipment. Never pull the cord itself.
7. Do not attempt to clean the unit with chemical solvents: this might damage the finish. Use a clean, dry cloth.
8. Be sure to read the "Troubleshooting" section on common operating errors before concluding that your unit is faulty.
9. This unit consumes a fair amount of power even when the power switch is turned off. We recommend that you unplug the power cord from the wall outlet if the unit is not going to be used for a long time. This will save electricity and help prevent fire hazards. To disconnect the cord, pull it out by grasping the plug. Never pull the cord itself.
10. To prevent lightning damage, pull out the power cord and remove the antenna cable during an electrical storm.
11. The general digital signals may interfere with other equipment such as tuners or receivers. Move the system farther away from such equipment if interference is observed.

NOTE:

Please check the copyright laws in your country before recording from records, compact discs, radio, etc. Recording of copyrighted material may infringe copyright laws.

Voltage Selector (General Model Only)

Be sure to position the voltage selector to match the voltage of your local power lines before installing the unit.

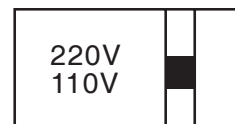



Welcome

And thank you for purchasing the **CDG-6000RV** from VocoPro, your ultimate choice in Karaoke entertainment! With years of experience in the music entertainment business, VocoPro is a leading manufacturer of Karaoke equipment, and has been providing patrons of bars, churches, schools, clubs and individual consumers the opportunity to sound like a star with full-scale club models, in-home systems and mobile units. All our products offer solid performance and sound reliability, and to reinforce our commitment to customer satisfaction, we have customer service and technical support professionals ready to assist you with your needs. We have provided some contact information for you below.

VocoPro

1728 Curtiss Court
La Verne, CA 91750
Toll Free: 800-678-5348
TEL: 909-593-8893
FAX: 909-593-8890

VocoPro Company Email Directory

Customer Service & General Information

info@vocopro.com

Tech Support

techsupport@vocopro.com

Remember Our Website

Be sure to visit the VocoPro website **www.vocopro.com** for the latest information on new products, packages and promos. And while you're there don't forget to check out our Club VocoPro for Karaoke news and events, chat rooms, club directories and even a KJ Service directory!

We look forward to hearing you sound like a PRO, with VocoPro, the singers ultimate choice.

FOR YOUR RECORDS

Please record the model number and serial number below, for easy reference, in case of loss or theft. These numbers are located on the rear panel of the unit. Space is also provided for other relevant information

Model Number _____

Serial Number _____

Date of Purchase _____

Place of Purchase _____

Listening for a lifetime

Selecting fine audio equipment such as the unit you've just purchased is only the start of your musical enjoyment. Now it's time to consider how you can maximize the fun and excitement your equipment offers. VocoPro and the Electronic Industries Association's Consumer Electronics Group want you to get the most out of your equipment by playing it at a safe level. One that lets the sound come through loud and clear without annoying blaring or distortion and, most importantly, without affecting your sensitive hearing.

Sound can be deceiving. Over time your hearing 'comfort level' adapts to a higher volume of sound. So what sounds 'normal' can actually be loud and harmful to your hearing. Guard against this by setting your equipment at a safe level BEFORE your hearing adapts.

To establish a safe level:

- Start your volume control at a low setting.
- Slowly increase the sound until you can hear it comfortably and clearly, and without distortion.

Once you have established a comfortable sound level:

- Set the dial and leave it there.
- Pay attention to the different levels in various recordings.

Taking a minute to do this now will help to prevent hearing damage or loss in the future. After all, we want you listening for a lifetime.

Used wisely, your new sound equipment will provide a lifetime of fun and enjoyment. Since hearing damage from loud noise is often undetectable until it is too late, this manufacturer and the Electronic Industries Association's Consumer Electronics Group recommend you avoid prolonged exposure to excessive noise. This list of sound levels is included for your protection.

Some common decibel ranges:

Level	Example
30	Quiet library, Soft whispers
40	Living room, Refrigerator, Bedroom away from traffic
50	Light traffic, Normal Conversation
60	Air Conditioner at 20 ft., Sewing machine
70	Vacuum cleaner, Hair dryer, Noisy Restaurant
80	Average city traffic, Garbage disposals, Alarm clock at 2 ft.

The following noises can be dangerous under constant exposure:

Level	Example
90	Subway, Motorcycle, Truck traffic, Lawn Mower
100	Garbage truck, Chainsaw, Pneumatics drill
120	Rock band concert in front of speakers
140	Gunshot blast, Jet plane
180	Rocket launching pad

-Information courtesy of the Deafness Research Foundation

Before Getting Started

Thank you for purchasing the CDG-6000RV Digital Karaoke CD+G/Cassette Amplifier. The CDG-6000RV will provide years of reliability and high quality entertainment for you if used properly. Please read this manual carefully before using your CDG-6000RV to ensure best performance.

Unpacking the CDG-6000RV

Carefully remove the CDG-6000RV from its carton. It is recommended that you store the original packaging materials in case you need to ship this equipment for any reason.

Be sure you have the following parts and components included with your CDG-6000RV:

ITEMS:	QUANTITY:
CDG-6000RV	1
A/V RCA Patch Cable	1
Remote Control	1
AA Batteries	2
AC Power Cable	1

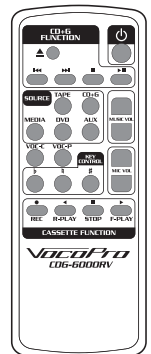
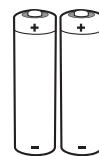
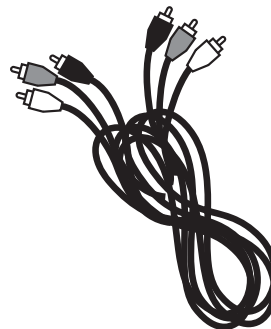
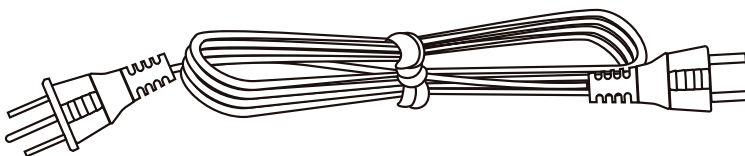
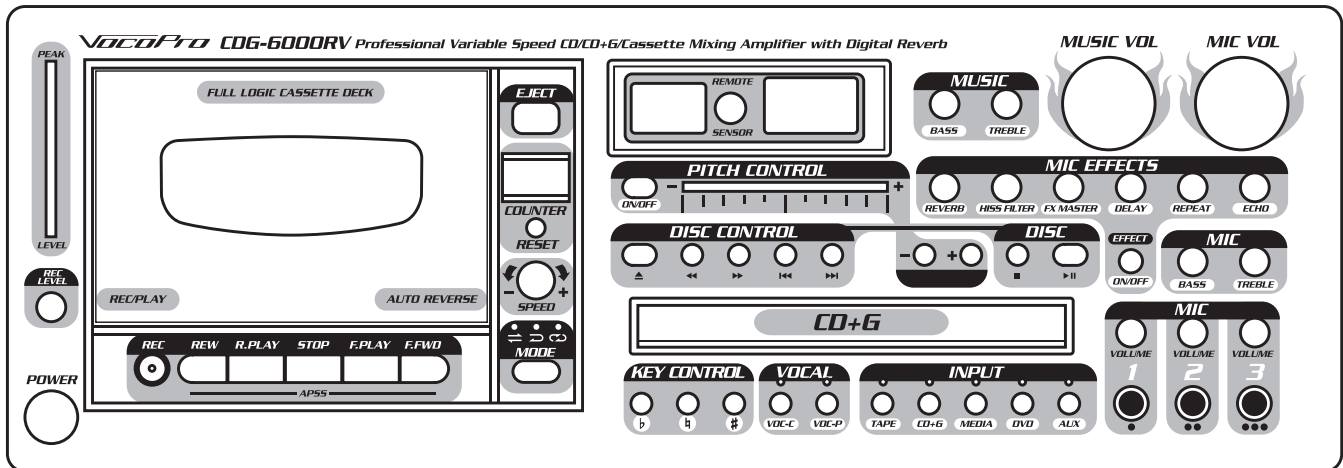

CDG-6000RV Features

Features:

- 125W + 125W Maximum Power Output at 8 Ohms
- 13-Step Digital Key Controller
- Built-In Variable Speed Cassette Deck with Record Level Control and Led Meter
- Built-In Variable Speed, Skip-Free, Shock-Resistant CD/CD+G Player
- Six Microphone Inputs with Three Channel Volume Controls
- Microphone Bass and Treble Controls
- Digital Echo Control for Professional Sounding Vocals
- Vocal Cancel/Partner Modes for Removing Vocals on Multiplexed Media
- Inputs: 2 A/V (RCA) and 1 AUX. (RCA)
- Outputs: 2 Audio (Rec & Pre-Out) and 1 Video (RCA)
- Music Bass and Treble Controls
- Remote Control
- 110V/220V Switchable
- NTSC/PAL Switchable

Getting Connected

Connecting input source players to the CDG-6000RV

The CDG-6000RV has stereo paired RCA inputs labeled for RCA stereo audio output from DVD, MEDIA and AUX players and two VIDEO inputs for corresponding video signals from DVD, and MEDIA players. The device associations are for reference only.

1. Use paired RCA stereo cables to output audio signal from your players to the corresponding CDG-6000RV DVD, MEDIA and AUX AUDIO INPUTS. Any other audio device with RCA stereo output can be connected to these inputs.
2. Connect the video outputs from your respective players to the CDG-6000RV's DVD, and MEDIA VIDEO INPUTS. Use RCA style video cables (usually coded in yellow) to carry the signal that will display Karaoke graphics and video to TVs or other monitor devices when output from the CDG-6000RV (see Connecting TVs/Monitors).

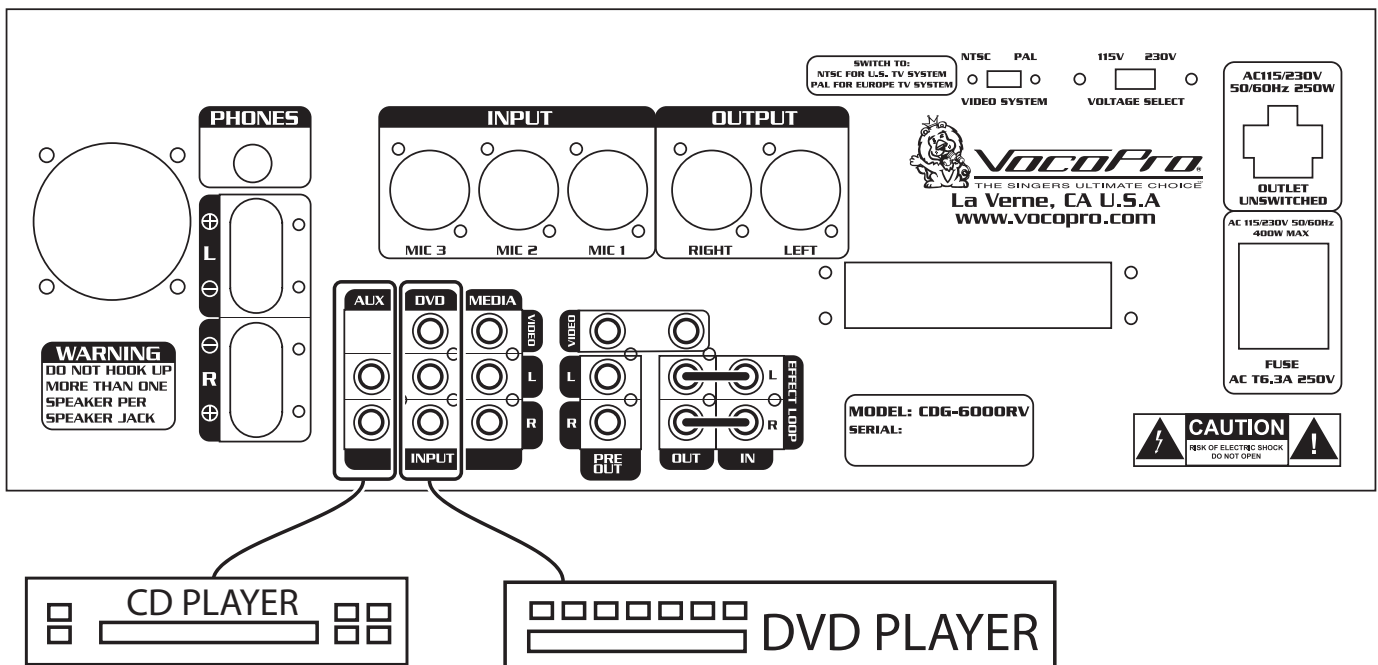

Getting Connected cont.

Connecting TVs/Monitors to the CDG-6000RV

The CDG-6000RV has two VIDEO OUTPUT jacks which send video and/or decoded CD+G graphics to TVs and other video monitor devices.

1. Connect an RCA style video cable from a VIDEO OUTPUT on the CDG-6000RV to the VIDEO INPUT jack on your TV or other monitor. You may need to manually switch your TV to video mode, while some models automatically switch when a video signal is detected. On most TVs, the INPUT jack is labeled A/V, AUX or VIDEO IN.

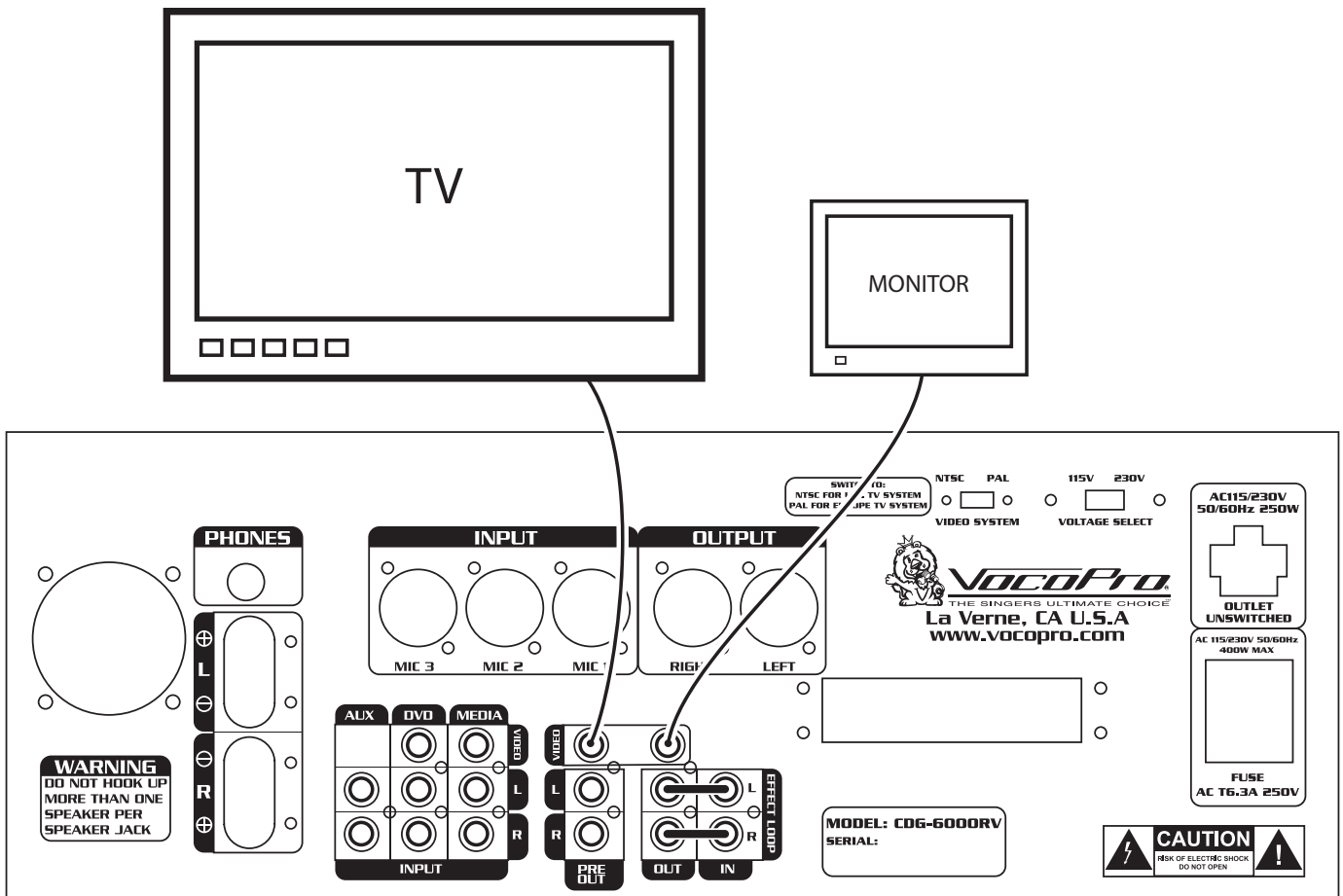

Getting Connected cont.

Connecting an External Effects or EQ Device to the CDG-6000RV

The CDG-6000RV has EFFECT LOOP INPUT and OUTPUT jacks that can be used to add additional effects to the audio signal which is sent to the speakers.

1. Remove the EFFECT LOOP BARS and store them in a safe place.
2. Connect an L/R RCA cable from the EFFECT LOOP OUTPUT on the CDG-6000RV rear panel to the INPUT jack on the External Effects or EQ device.
3. Connect an L/R RCA cable from the OUTPUT of the EXTERNAL EFFECTS or EQ DEVICE to the EFFECT LOOP INPUT on the CDG-6000RV rear panel.

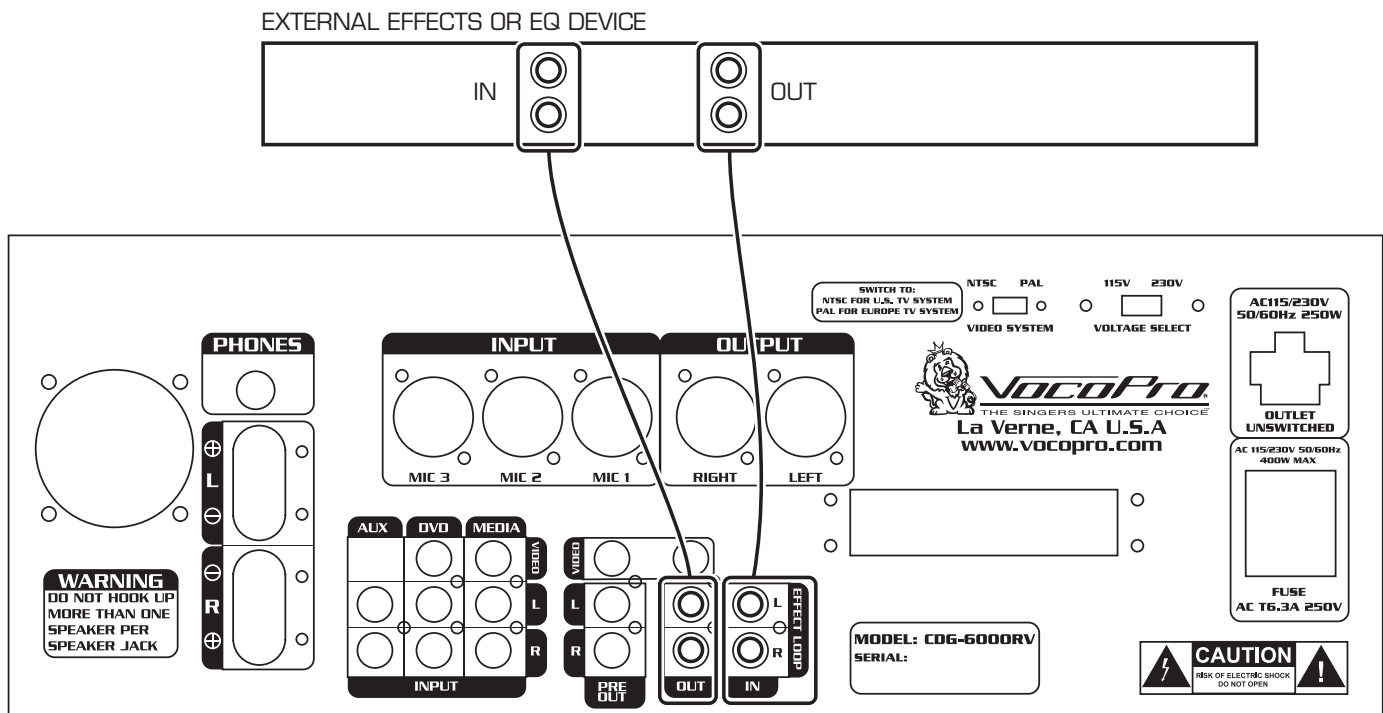

Getting Connected cont.

Connecting Speakers

The Speaker Terminals are located on the rear panel. There are two SPEAKER terminals. Be sure to connect the left channel (L), right channel (R), "+" (red) and "-" (black) properly.

CDG-6000RV rear panel

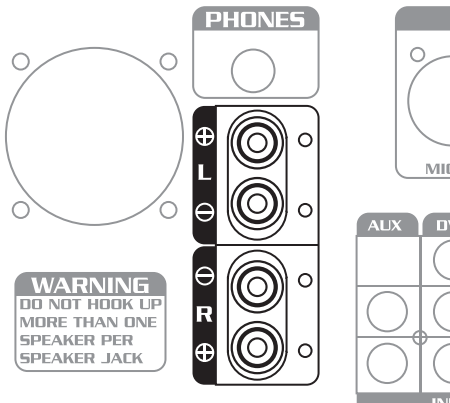

- Before connecting the speakers, make sure that the CDG-6000RV is disconnected from the power source.
- Do not let the bare speaker wires touch each other or another metal part of this unit. This could damage the CDG-6000RV and/or the speakers.

Determining the proper way to connect the speaker cables:

The speaker cable is a pair of insulated cables running side by side. One cable is colored or shaped differently, perhaps with a stripe, groove or ridges.

1. Connect one end of the striped (grooved, ridged, etc.) cable to the "+" (red) terminal on the rear panel of the CDG-6000RV.
2. Connect the other end of the striped (grooved, ridged, etc.) cable to the "+" (red) terminal on the speaker.
3. Connect one end of the "plain" (NO stripes, grooves, ridges, etc.) cable to the "-" (black) terminal on the rear panel of the CDG-6000RV.
4. Connect the other end of the "plain" (NO stripes, grooves, ridges, etc.) cable to the "-" (black) terminal on the speaker.

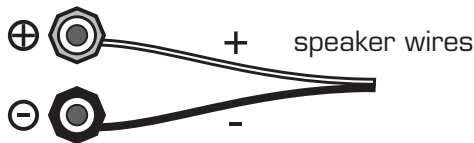

CDG-6000RV connectors

Preparing the Speaker Cable

You can either use an exposed speaker wire or Banana Plug speaker cable.

Exposed Speaker Wire

1. Remove approximately 3/8" (10mm) of insulation

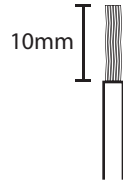

2. Twist the exposed wires together to prevent short circuits

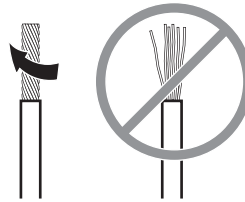

3. Loosen the knob on the speaker terminal
4. Insert the bare wire
5. Tighten the knob until the wire is secure

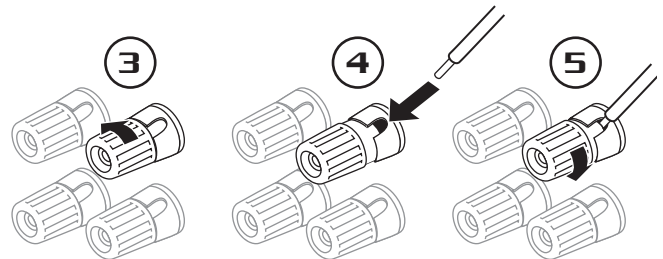

Banana Connector

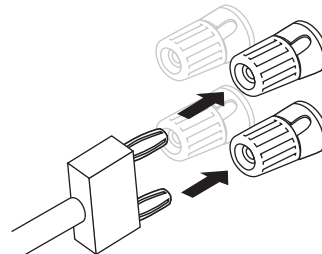

Front Panel Descriptions and Functions

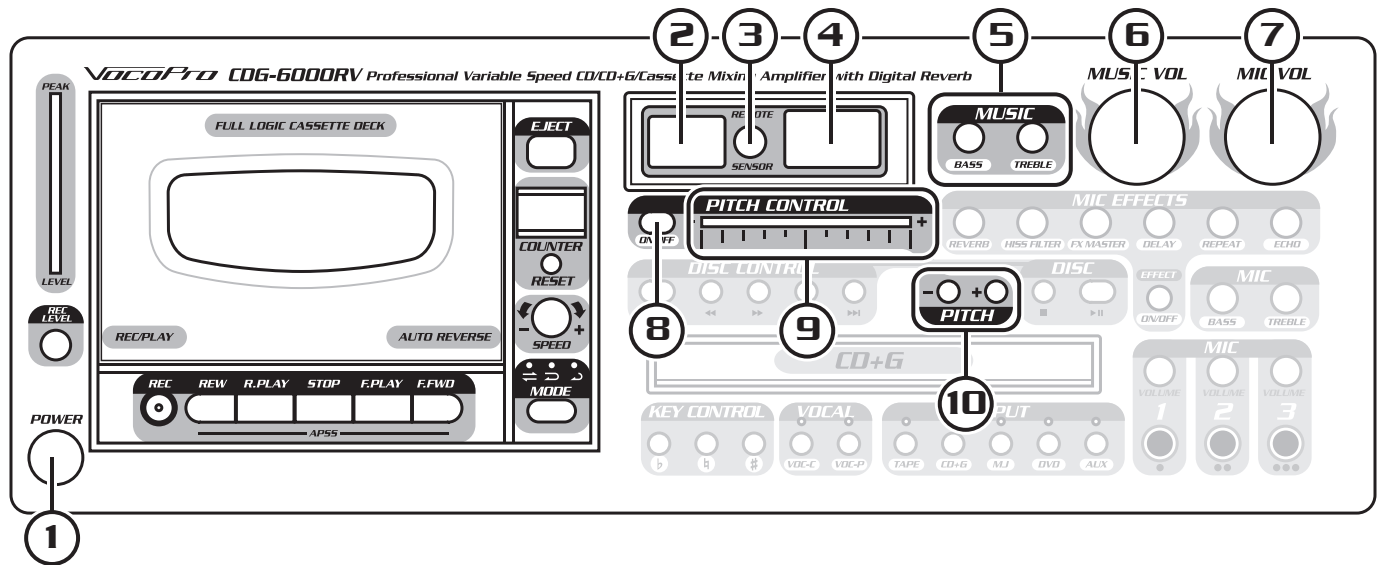

1. **POWER** - Use this button to turn the CDG-6000RV ON or OFF.
2. **KEY CONTROL DISPLAY** - Displays key control setting information.
3. **REMOTE SENSOR** - When operating the CDG-6000RV with the REMOTE CONTROL, direct the REMOTE towards this SENSOR within 23 feet. Maintain a line of sight between REMOTE and REMOTE SENSOR clear of obstacles to prevent signal deflection.
4. **DISPLAY** - Displays setting information.
5. **MUSIC BASS/TREBLE CONTROL** - These controls adjust the bass and treble of the music output. Turn clockwise to increase output and counter-clockwise to decrease.
6. **MUSIC VOLUME** - This control adjusts the output level for whichever player connected to an AUDIO INPUT and assigned with the INPUT selector. Turn clockwise to increase output and counter-clockwise to decrease.
7. **MIC VOLUME** - This control adjusts the output level for MIC 1, 2 and 3. Turn clockwise to increase output and counter-clockwise to decrease.
8. **PITCH ADJUST ON/OFF** - Turn the pitch adjust on or off by pushing this button.
9. **PITCH SLIDER** - Adjust the speed of your music, slide right to increase, left to decrease.
10. **PITCH CONTROL** - This control temporarily changes the pitch of the music.

Front Panel Descriptions and Functions cont.

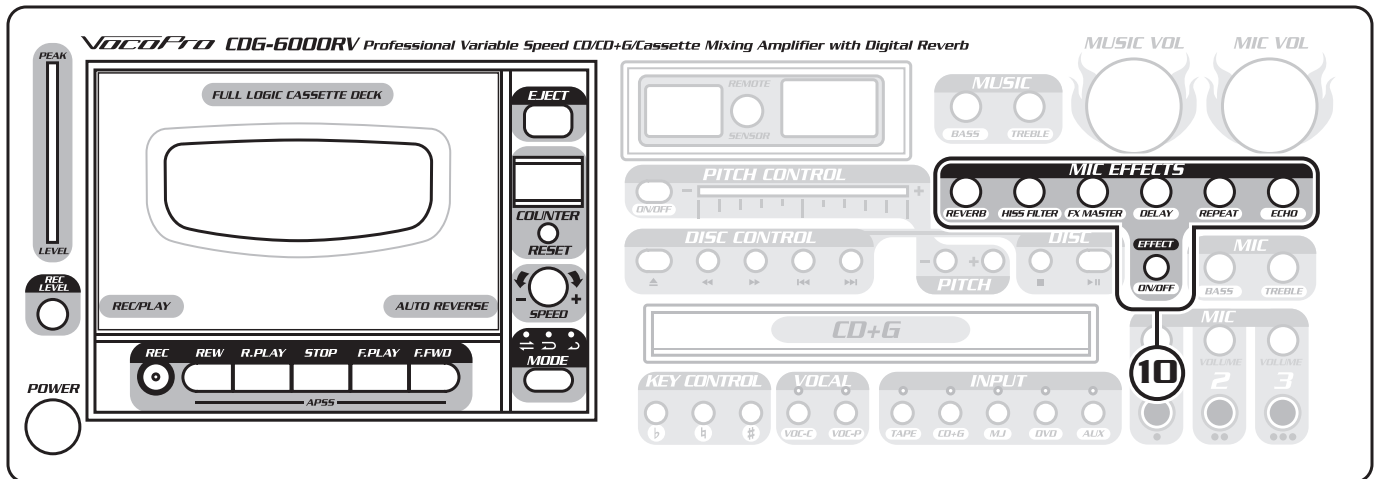

10. MIC EFFECTS - Add effects to your vocal output to give it a professional edge.

REVERB KNOB - This controls the overall level for the REVERB effect on all three MIC INPUTS. This effect gives a spacious or ambient feeling that works great with vocals. Rotate clockwise to increase the amount of REVERB effect applied to the signal, and counter-clockwise to decrease.

HISS FILTER KNOB - Eliminate hiss sounds from the vocal output by rotating the HISS FILTER control clockwise.

FX MASTER KNOB - Control the level of all effects.

DELAY KNOB - This control adjusts the length of time for each ECHO interval, or REPEAT. Rotating the DELAY control clockwise will increase the DELAY, creating the effect of more "space."

REPEAT KNOB - This control adjusts the number of ECHO repeats applied to the signal until the effect decays, or fades out.

ECHO KNOB - This controls the overall level for the ECHO effect on all three MIC INPUTS. This effect applies slight delayed repetition(s) to the vocals providing for a rich, layered vocal sound. Rotate clockwise to increase the amount of ECHO effect applied to the signal, and counter-clockwise to decrease.

EFFECT BUTTON - Enable or disable the effects on your vocal output.

Front Panel Descriptions and Functions cont.

+6/Cassette Mixing Amplifier with Digital Reverb

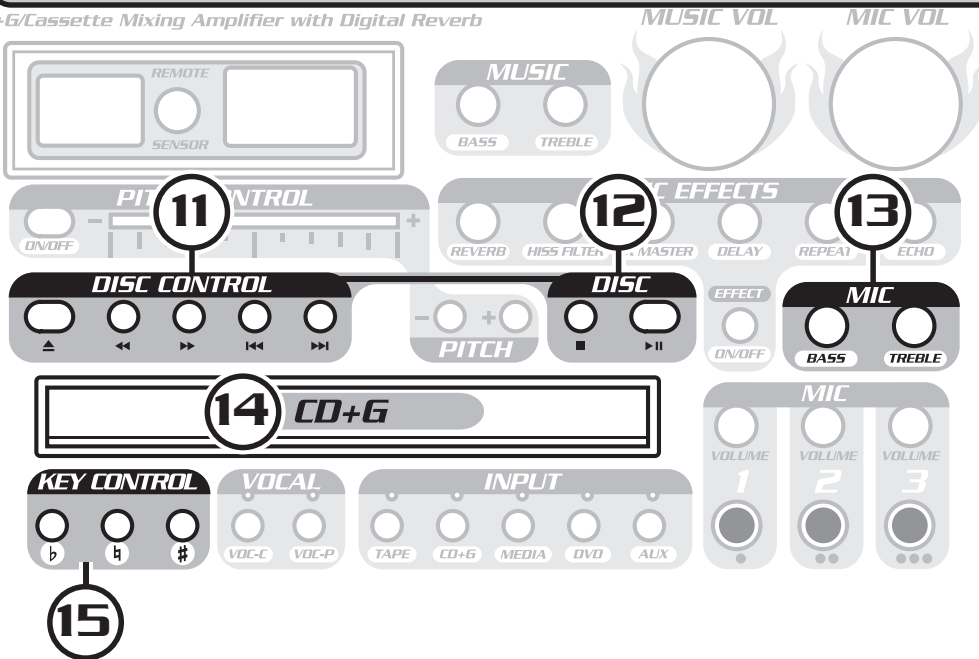

DISC CONTROL

11. **OPEN/CLOSE** Button - Opens and closes the disc tray

PREV and NEXT Buttons - Press PREV to jump to the previous track and NEXT to jump to the next track.

SCAN Buttons - For scanning through a track. scans backwards and scans forwards.

12. **PLAY/PAUSE** Button - Plays a disc that is stopped or paused and pauses a disc that is playing.

STOP Button - Stops a disc that is playing.

13. **BASS/TREBLE** - Control the low (bass) or high (treble) ends of your Mic output.

14. **DISC TRAY** - Press the "OPEN/CLOSE" button (See #11 on diagram) to open the CD/CDG tray. Carefully set your CD/CDG disc onto the tray and press the OPEN/CLOSE button again to close tray. Never push or force tray closed manually.

15. **DIGITAL KEY CONTROL** - You can adjust the key of your source music in half-step increments to match the natural range of your voice using the KEY CONTROL buttons. To flat (b) or lower the key, press the flat (b) button on the left side of the KEY CONTROL controls. To sharp (#) or raise the key, press the sharp (#) button on the right side of the KEY CONTROL controls. To return to the original key of the music input source, press the center natural (h) button. You will see the KEY CONTROL DISPLAY reflect the KEY CONTROL step you have selected. The increase in numbers for both flat (b) and sharp (#) represent an increase in amount of key change from the original or natural, 1 being the least amount, 6 being the most (the numbers will appear as negatives to measure flat).

Front Panel Descriptions and Functions cont.

+6/Cassette Mixing Amplifier with Digital Reverb

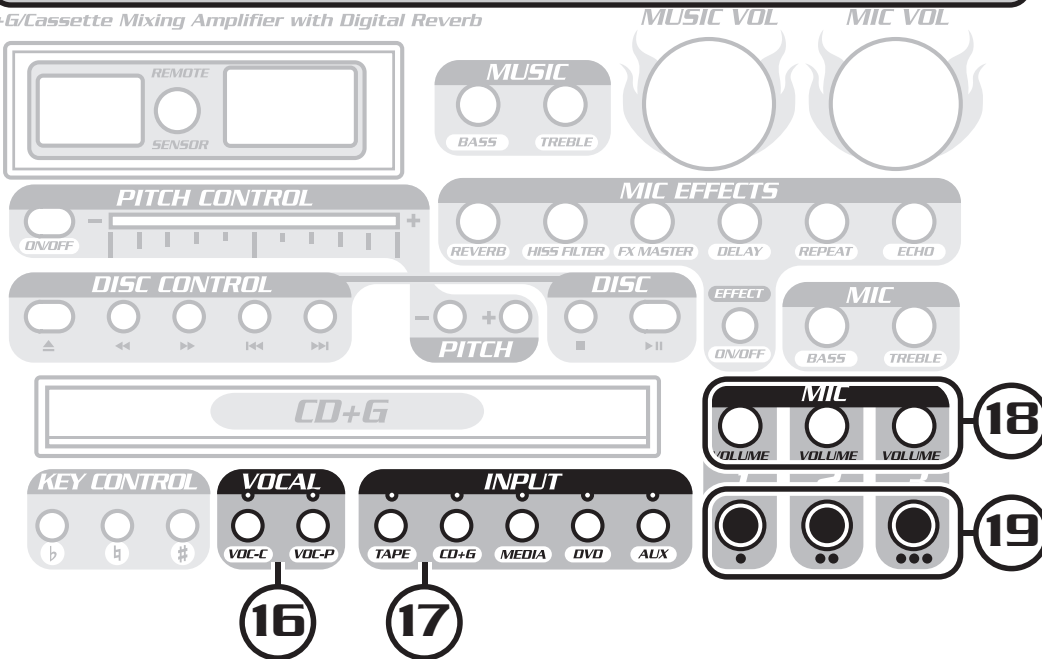

16. VOCAL CANCEL/VOCAL PARTNER -

VOC/C: Vocal Cancel key. This feature is designed to work only with “multiplex” karaoke discs. By pressing this key the “guide” or “lead” vocal on the multiplex disc will be removed throughout the entire song. To hear the guide/lead vocal press the key again.

VOC/P: Vocal Partner key. This feature is designed to work only with “multiplex” karaoke discs. By pressing this key the “guide” or “lead” vocal on the multiplex disc will be removed when you are singing. When you stop singing the “guide/lead” vocal will again become audible, so it’s like having a “vocal partner”. For example, if you want to sing every other verse in a song you may do so when using this feature. The “guide/lead” vocal will automatically begin a second after you stop singing and become inaudible when you resume singing until the VOC/P key is pressed again.

17. INPUT SELECTOR - Change the input source by pressing the corresponding button to the input device.

18. MICROPHONE VOLUME CONTROLS - These level controls for MIC 1, 2 and 3 should be adjusted individually to get the best mix when multiple performers are singing. Rotate clockwise to increase and counter-clockwise to decrease VOLUME for each mic.

19. MIC 1, 2, 3 INPUTS - Connect your ¼” cabled microphones into any of these three inputs.

Cassette Deck Descriptions and Functions

VocoPro CDG-6000RV Professional Variable Speed CD/C

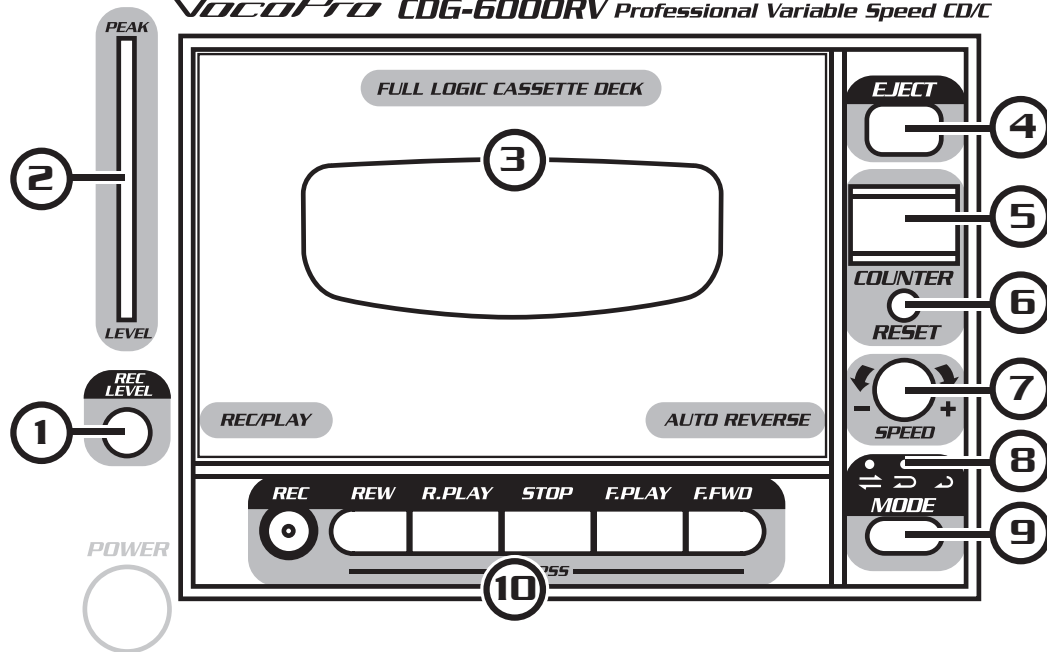

1. **LEVEL KNOB** - When recording to the cassette deck, use this control to increase or decrease the incoming signal level for precise recording results.
2. **LEVEL INDICATOR** - This LED meter reflects the record signal level in "real-time" to allow for accurate record level adjustment.
3. **CASSETTE DECK** - Insert the tape here.
4. **EJECT BUTTON** - Press to open cassette door and insert or remove a tape.
5. **COUNTER DISPLAY** - Use the tape counter when playing or recording cassettes to keep track of your location on the tape.
6. **COUNTER RESET** - Reset the counter to zero.
7. **SPEED ADJUST KNOB** - Adjust the speed of your playback/recording by turning clockwise to increase the speed, turn counter-clockwise to decrease speed.
8. **PLAYBACK INDICATOR** - This indicates the playback mode enabled.
9. **MODE BUTTON** - Select three playback modes: SINGLE SIDE PLAYBACK, DUAL SIDE PLAYBACK, CONTINUOUS PLAYBACK.
10. **CASSETTE DECK CONTROLS:**
 - REC** - To enable record mode, press this button. For detailed instructions see "Cassette Deck Recording."
 - REW** - When playing a cassette, this key can be used to rewind the cassette to the previous location.
 - R. PLAY** - Play the reverse side of the tape.
 - STOP** - Press this key to stop a cassette from playing or recording.
 - F. PLAY** - Play the forward side of the tape.
 - F. FWD "FAST FORWARD"** - When playing a cassette, this key can be used to advance the cassette to the next desired location.

Rear Panel Descriptions and Functions

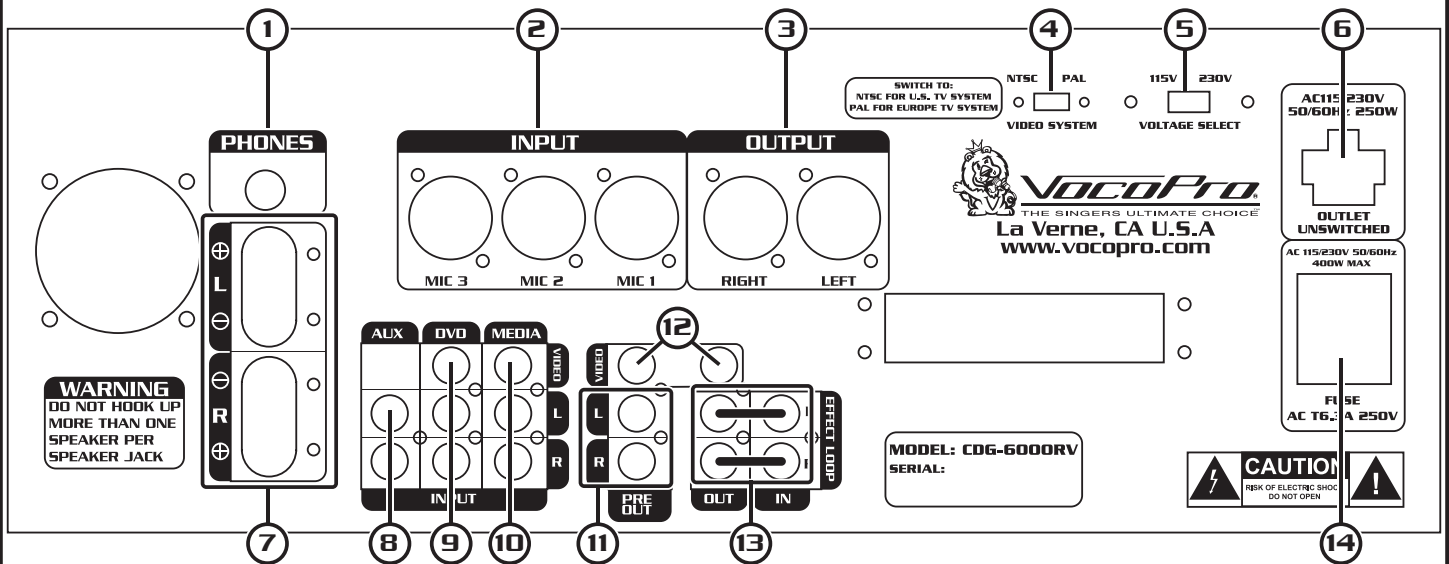

1. **HEADPHONE OUTPUT** - Connect headphones to this 1/4" input.
 2. **XLR MICROPHONE INPUTS** - Connect three XLR microphone connections here. Each input corresponds with controls on the front panel of the CDG-6000RV.
 3. **XLR STEREO OUTPUT** - Output the CDG-6000RV via left and right XLR cables.
 4. **NTSC/PAL SELECTOR SWITCH** - This switch is used to select the NTSC/PAL setting according to country. For U.S. television systems it should be set to NTSC and for European television systems the selector should be set to PAL.
 5. **VOLTAGE SELECTOR SWITCH** - This switch is used to select the voltage setting according to country. For use in the U.S. the voltage selector should be set to 115V and 230V in Europe.
 6. **115V/230V AC OUTLET** - This outlet can be used to connect another component providing it does not exceed 250 watts maximum power consumption.
 7. **SPEAKER JACKS** - Use these speaker jacks to connect speakers.
 8. **AUX AUDIO INPUT** - Connect RCA stereo cables from your audio output device.
 9. **DVD INPUT** - Connect RCA stereo and video cables from your DVD player output.
 10. **MEDIA INPUT** - Connect any additional media player or audio output device to this audio/video RCA connection.
 11. **AUDIO PRE-AMP OUTPUT** - Output the audio from your CDG-6000RV via RCA audio cables.
 12. **VIDEO OUTPUT** - Output the video from your CDG-6000RV via RCA video cables.
 13. **EFFECT LOOP INPUT/OUTPUT** - These jacks allow an External Effect or EQ Device to be connected to the CDG-6000RV and applied to the source music (see page 10 for more details).
- NOTE:** When an External Effect or EQ Device is not connected, the EFFECT LOOP BARS must be inserted for speaker output.
14. **POWER INPUT** - Connect the power cord (included) here.

Remote Control Descriptions and Functions

The maximum operating distance between the Remote Control and the REMOTE SENSOR is approximately 23 feet. If the effective distance of the Remote decreases, replace the batteries. To install new batteries, remove the battery compartment lid on the back of the Remote and insert two AA batteries with polarities aligned.

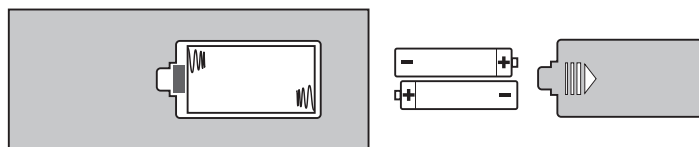

1. CD+G FUNCTION:

- ▲ **Open/Close Button** - Opens and closes the disc tray.
- ⏮ **Previous Button** - Press ⏮ to jump to the previous track.
- ⏭ **Next Button** - Press ⏭ to jump to the next track.
- ■ **Stop Button** - Stops the disc.
- ▶ **Play Button** - Plays a disc.
- || **Pause Button** - Pause the disc.

2. SOURCE - This button allows you to select between TAPE, CD+G, DVD, MEDIA and AUX player source to the CDG-6000RV. This allows the CDG-6000RV to differentiate between all the related sources and AUDIO INPUT options available on the back panel.

3. VOCAL CANCEL/VOCAL PARTNER:

VOC/C: Vocal Cancel key. This feature is designed to work only with "multiplex" karaoke discs. By pressing this key the "guide" or "lead" vocal on the multiplex disc will be removed throughout the entire song. To hear the guide/lead vocal press the key again.

VOC/P: This feature is designed to work only with "multiplex" karaoke discs. By pressing this key the "guide" or "lead" vocal on the multiplex disc will be removed when you are singing. When you stop singing the "guide/lead" vocal will again become audible, so it's like having a "vocal partner". For example, if you want to sing every other verse in a song you may do so when using this feature. The "guide/lead" vocal will automatically begin a second after you stop singing and become inaudible when you resume singing until the VOC/P key is pressed again.

4. DIGITAL KEY CONTROL - You can adjust the key of your source music in half-step increments to match the natural range of your voice using the KEY CONTROL buttons on the remote control. Press any of the four flat (b) buttons on the left side of the KEY CONTROL controls to select a flat (b) or (lower) key. Press any of the four sharp (#) buttons on the right side of the KEY CONTROL controls to select a sharp (#) or (higher) key. To return to the original key of the music input source, press the center natural (♮) button. You will see the KEY CONTROL DISPLAY reflect the KEY CONTROL step you have selected. The increase in numbers for both flat (b) and sharp (#) represent an increase in amount of key change, 1 being the least amount, 6 being the most (the numbers will appear as negatives to measure flat).

5. CASSETTE FUNCTION

- ▶ **Forward Play Button** - Plays the forward side of the tape.
- ◀ **Reverse Play Button** - Plays the reverse side of the tape.
- ● **Record Button** - press this button and the cassette will begin recording.
- ■ **Stop Button** - Stops the tape.

6. STANDBY - Puts the CDG-6000RV in standby mode.

7. MUSIC VOLUME - Use the ▲ to raise the MUSIC VOLUME and the ▼ to lower the MUSIC VOLUME.

8. MIC VOLUME - Use the ▲ to raise the MIC MASTER VOLUME and the ▼ to lower this mixed MIC MASTER VOLUME.

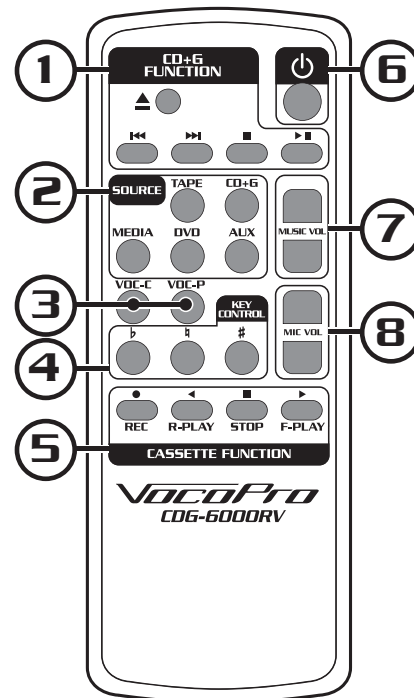

Cassette Deck Recording

You can record yourself singing with a Karaoke CD/CD+G track for demos, practicing or just plain fun.

1. Select the desired "track" (song), and make sure a microphone is connected. Also set the mic echo, bass and treble settings now if they need to be changed.
2. Begin the CD/CD+G track and sing to it at the level you will be singing when recording.
3. After a desired mix of music and vocals is reached, restart the track and sing as you did previously. This time you will need to set the RECORDING INPUT LEVEL of the cassette deck to a desired level for great quality recordings. Using the LED METER to gauge the signal level, turn the RECORD LEVEL CONTROL clockwise to increase the signal gain, or counter-clockwise to decrease the signal gain. Most audio professionals shoot for a recording level that remains above the top GREEN LED and below the first RED LED.
4. Be sure the blank cassette tape is placed in the cassette deck and the cassette door closed.
5. Set the Tape counter to zero by pushing the "RESET" button located next to the "COUNTER" on the front of the unit. This will help you keep track of your place on the tape if you are recording multiple songs but not starting from the beginning of the tape.

NOTE: If you have rewound the cassette tape all the way to the beginning note that there are a few seconds of "leader" tape at each end of the cassette on which you cannot record.

4. Locate the REC button on the cassette deck and press it to enable RECORD MODE. The FPLAY and RPLAY buttons will be lit, select the side that you wish to record to by pressing either of these buttons. The REC button will be lit to indicate record mode has been enabled.
5. View the advancing cassette through the cassette door window and let tape run until it has passed the "leader" tape. If it is not visible, allow approximately 10 seconds to let the tape "roll" then locate and press the PAUSE key. This will stop the cassette from advancing but it will still be in the "record" mode. Leave the PAUSE button pressed.
6. Press the PLAY on the CD/CD+G controls to start the CD/CD+G track selection.
7. At the same time, release the PAUSE button on the cassette deck and the tape will start "rolling". Your selection and voice is now being recorded.

NOTE: Be careful not to "thump" the microphone while holding it or while singing. This will create noise that will be noticeable on your recording. Tip: When recording, be careful not to "pop" the microphone with "plosive" consonants like "P" and "T". Excessive breath on these consonants will create an undesirable "pop" sound on your recording.

CDG-6000RV Specifications

MAX POWER OUTPUT.....125W + 125W (8Ω)
TOTAL HARMONIC DISTORTION0.05% (1 kHz, 60W, 8Ω)

AUDIO

MICROPHONE2.5mv/10k Ohms
BGM/DVD/CD/AUX150mv/50k Ohms

VIDEO

DVD/ AUX / CDG1V P-P/75 Ohms

FREQUENCY RESPONSE

MIC40Hz-15kHz ±3dB
MUSIC20Hz-20kHz ±3dB

TONE CONTROL (MUSIC / MIC)

BASS±10dB/±8dB (100Hz)±3
TREBLE±10dB/±8dB (10kHz)±3
ECHO REPEAT30% ~ 80%
ECHO VOLUME0% ~ 100%
ECHO DELAY TIME140Msec ~ 240Msec
REVERB VOLUME0~99 1.5/Step
REVERB TIME.....0~99 1.0/Step
KEY CONTROL RANGE+6/-6 KEY MUSIC INTERVALS(13 POSITIONS)
SIGNAL TO NOISE RATIO>75db
CASSETTE MOTOR SPEED (ATT-111N 3kHz) 2940Hz-3090Hz
CASSETTE WOW-FILTER (ATT-111N 3kHz) .<0.3%
CD+G PITCH CONTROL±10%

SPEAKER IMPEDANCE

ONE CHANNEL (1 OR 2)4 - 16Ω
TWO CHANNELS (1 AND 2).....8 - 32Ω

POWER SUPPLY, OTHER

POWER REQUIREMENTSAC 110V/220V 50Hz/60Hz
POWER CONSUMPTION600 WATT

DIMENSIONS

(W x D x H):.....17in, 16.5in, 6.5in
WEIGHT24lbs (10.9kg)

ACCESSORIES

AC POWER CORD.....1
RCA CABLES.....1
OPERATING INSTRUCTIONS.....1
REMOTE CONTROL1
WARRANTY CARD.....1

Troubleshooting

Problem	Solution
No sound output	<ul style="list-style-type: none">• Make sure the CDG-6000RV is set to the correct input.• Make sure the volume is turned up.• Make sure everything is connected firmly and properly.• Make sure there are no defective cables.• Make sure all of your components are turned on.• Make sure the EFFECT LOOP BARS are in place.
There is music but no microphone vocals.	<ul style="list-style-type: none">• Make sure the microphone is turned on.• Make sure the microphone cable is not disconnected or damaged.• Make sure the microphone master volume or individual microphone volume controls are turned up to the proper level.
The remote control is not working.	<ul style="list-style-type: none">• The CDG-6000RV power is not on.• Make sure the batteries are inserted correctly and not out of power.• Make sure there is nothing blocking the view between the remote control and the remote sensor on the front of the CDG-6000RV.
The recording level is too low.	<ul style="list-style-type: none">• Make sure that the recording level knob is at an acceptable position for your recording.

Notes

VocoPro[®]

THE SINGER'S ULTIMATE CHOICE[™]

