

VocoPro[®]

THE SINGER'S ULTIMATE CHOICE[™]

FEATURES:

- 180W + 180W maximum power output Mixing Amplifier
- Vocal Enhancer with High and Low Contour, Tune and Process controls for optimal vocal reproduction and rich, vibrant sound
- 13-step Digital Key Controller for transposing natural key of source music
- Vocal Cancel/Vocal Partner modes for removing or adding guide vocals from Multiplex Karaoke media
- Digital Echo with Repeat and Delay controls to add depth and space to vocals
- Three Microphone Inputs with individual Volume controls
- Full-function remote control for ease of operation
- Master Music and Microphone Volume controls
- LED Gain setting to toggle display intensity
- Loudness boost for instant audio gain
- 3 RCA style Video Inputs and 3 Video Outputs
- Dedicated Audio Ins for CD, CDG, LD and DVD
- Dedicated Wireless Mic Input and Mic Insert
- Mic Output with switchable Echo
- Connects up to 4 speakers with A/B switch between pairs

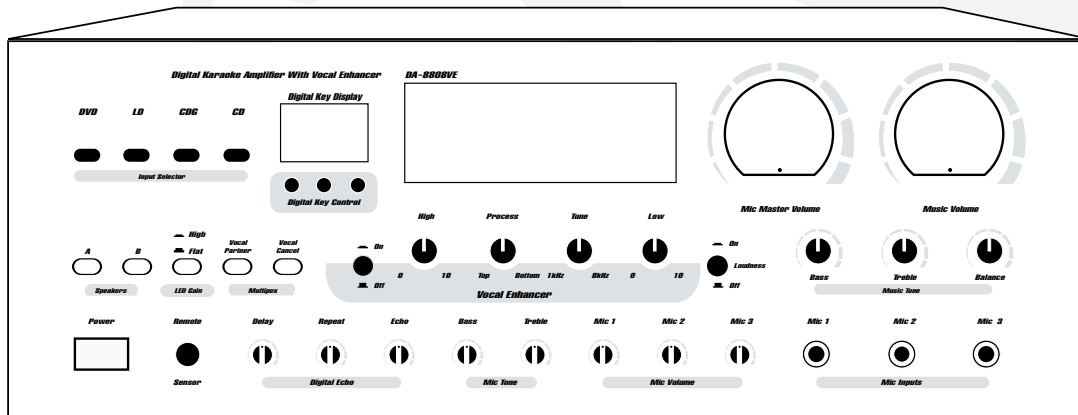

DA-8808VE

Digital Karaoke Amplifier/Mixer With Vocal Enhancer

o w n e r ' s m a n u a l

Table of contents

Introduction

Safety instructions	2-3
Welcome	4
Listening for a lifetime	5
Before getting started	6

Getting Connected

Connecting input source players	7
Connecting TV's/monitors	8

Descriptions and Functions

Front panel.....	9-11
Rear panel	12-13
Remote Control.....	14

Advanced operations.....	15
--------------------------	----

Specifications.....	16
---------------------	----



JocoPro[®]
THE SINGER'S ULTIMATE CHOICE[™]

Safety Instructions



CAUTION
RISK OF SHOCK



CAUTION: To reduce the risk of electric shock, do not remove cover (or back). No user-serviceable parts inside. Only refer servicing to qualified service personnel.

Explanation of Graphical Symbols



The lightning flash & arrowhead symbol, within an equilateral triangle, is intended to alert you to the presence of danger.



The exclamation point within an equilateral triangle is intended to alert you to the presence of important operating and servicing instructions.

WARNING

To reduce the risk of fire or electric shock, do not expose this unit to rain or moisture.

1. Read Instructions - All the safety and operating instructions should be read before the appliance is operated.

2. Retain Instructions - The safety and operating instructions should be retained for future reference.

3. Heed Warnings - All warnings on the appliance and in the operating instructions should be adhered to.

4. Follow Instructions - All operating and use instructions should be followed.

5. Attachments - Do not use attachments not recommended by the product manufacturer as they may cause hazards.

6. Water and Moisture - Do not use this unit near water. For example, near a bathtub or in a wet basement and the like.

7. Carts and Stands - The appliance should be used only with a cart or stand that is recommended by the manufacturer.

7 A. An appliance and cart combination should be moved with care. Quick stops, excessive force, and uneven surfaces may cause an overturn.



8. Ventilation - The appliance should be situated so its location does not interfere with its proper ventilation. For example, the appliance should not be situated on a bed, sofa, rug, or similar surface that may block the ventilation slots.

9. Heat - The appliance should be situated away from heat sources such as radiators, heat registers, stoves, or other appliances (including amplifiers) that produce heat.

10. Power Sources - The appliance should be connected to a power supply only of the type described in the operating instructions or as marked on the appliance.

11. Grounding or Polarization - Precautions should be taken so that the grounding or polarization means of an appliance is not defeated.

12. Power-Cord Protection - Power-supply cords should be routed so that they are not likely to be walked on or pinched by items placed upon or against them, paying particular attention to cords at plugs, convenience receptacles, and the point where they exit from the appliance.

13. Cleaning - Unplug this unit from the wall outlet before cleaning. Do not use liquid cleaners or aerosol cleaners. Use a damp cloth for cleaning.

14. Power lines - An outdoor antenna should be located away from power lines.

15. Nonuse Periods - The power cord of the appliance should be unplugged from the outlet when left unused for a long period of time.

16. Object and Liquid Entry - Care should be taken so that objects do not fall and liquids are not spilled into the enclosure through openings.

17. Damage Requiring Service - The appliance should be serviced by qualified service personnel when:

- A. The power supply cord or plug has been damaged; or
- B. Objects have fallen into the appliance; or
- C. The appliance has been exposed to rain; or
- D. The appliance does not appear to operate normally or exhibits a marked change in performance; or
- E. The appliance has been dropped, or the enclosure damaged.

18. Servicing - The user should not attempt to service the appliance beyond that described in the operating instructions. All other servicing should be referred to qualified service personnel.

Note:

To CATV system installer's (U.S.A.): This reminder is provided to call the CATV system installer's attention to Article 820-40 of the NEC that provides guidelines for proper grounding and, in particular, specifies that the cable ground shall be connected as close to the point of cable entry as practical.

FCC INFORMATION (U.S.A.)

1. IMPORTANT NOTICE: DO NOT MODIFY THIS

UNIT!: This product, when installed as indicated in the instructions contained in this manual, meets FCC requirements. Modifications not expressly approved by Vocopro may void your authority, granted by the FCC, to use this product.

2. IMPORTANT: When connecting this product to accessories and/or another product use only high quality shielded cables. Cable(s) supplied with this product **MUST** be used. Follow all installation instructions. Failure to follow instructions could void your FCC authorization to use this product in the U.S.A.

3. NOTE: This product has been tested and found to comply with the requirements listed in FCC Regulations, Part 15 for Class "B" digital devices. Compliance with these requirements provides a reasonable level of assurances that your use of this product in a residential environment will not result in harmful interference with other electronic devices. This equipment generates/uses radio frequencies and, if not installed and used according to the instructions found in the owner's manual, may cause interference harmful to the operation of other electronic devices. Compliance with FCC regulations does not guarantee that interference will not occur in all installations. If this product is found to be the source of interference, which can be determined by turning the unit "Off" and "On", please try to eliminate the problem by using one of the following measures:

Relocate either this product or the device that is being affected by the interference.

Use power outlets that are on different branch (circuit breaker or fuse) circuits or install AC line filter(s).

In the case of radio or TV interference, relocate/reorient the antenna. If the antenna lead-in is 300-ohm ribbon lead, change the lead-in to coaxial type cable.

If these corrective measures do not produce satisfactory results, please contact your local retailer authorized to distribute Vocopro products. If you can not locate the appropriate retailer, please contact Vocopro, 1728 Curtiss Court, La Verne, CA 91750.

CAUTION

The apparatus is not disconnected from the AC power source so long as it is connected to the wall outlet, even if the apparatus itself is turned off. To fully insure that the apparatus is indeed fully void of residual power, leave unit disconnected from the AC outlet for at least fifteen seconds.

CAUTION:

READ THIS BEFORE OPERATING YOUR UNIT

1. To ensure the finest performance, please read this manual carefully. Keep it in a safe place for future reference.
2. Install your unit in a cool, dry, clean place - away from windows, heat sources, and too much vibration, dust, moisture or cold. Avoid sources of hum (transformers, v motors). To prevent fire or electrical shock, do not expose to rain and water.
3. Do not operate the unit upside-down.
4. Never open the cabinet. If a foreign object drops into the set, contact your dealer.
5. Place the unit in a location with adequate air circulation. Do not interfere with its proper ventilation; this will cause the internal temperature to rise and may result in a failure.
6. Do not use force on switches, knobs or cords. When moving the unit, first turn the unit off. Then gently disconnect the power plug and the cords connecting to other equipment. Never pull the cord itself.
7. Do not attempt to clean the unit with chemical solvents: this might damage the finish. Use a clean, dry cloth.
8. Be sure to read the "Troubleshooting" section on common operating errors before concluding that your unit is faulty.
9. This unit consumes a fair amount of power even when the power switch is turned off. We recommend that you unplug the power cord from the wall outlet if the unit is not going to be used for a long time. This will save electricity and help prevent fire hazards. To disconnect the cord, pull it out by grasping the plug. Never pull the cord itself.
10. To prevent lightning damage, pull out the power cord and remove the antenna cable during an electrical storm.
11. The general digital signals may interfere with other equipment such as tuners or receivers. Move the system farther away from such equipment if interference is observed.

NOTE:

Please check the copyright laws in your country before recording from records, compact discs, radio, etc. Recording of copyrighted material may infringe copyright laws.

Voltage Selector (General Model Only)

Be sure to position the voltage selector to match the voltage of your local power lines before installing the unit.

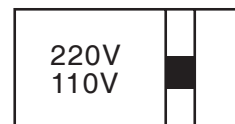



Welcome



And Thank you for purchasing the **DA-8808VE** from VocoPro, your ultimate choice in Karaoke entertainment! With years of experience in the music entertainment business, VocoPro is a leading manufacturer of Karaoke equipment, and has been providing patrons of bars, churches, schools, clubs and individual consumers the opportunity to sound like a star with full-scale club models, in-home systems and mobile units. All our products offer solid performance and sound reliability, and to further strengthen our commitment to customer satisfaction, we have customer service and technical support professionals ready to assist you with your needs. We have provided some contact information for you below.

VOCOPRO

1728 Curtiss Court
La Verne, CA 91750

Toll Free: 800-678-5348

TEL: 909-593-8893

FAX: 909-593-8890

VocoPro Company Email Directory

Customer Service & General Information

info@vocopro.com

Tech Support

techsupport@vocopro.com

Remember Our Website

Be sure to visit the VocoPro website **www.vocopro.com** for the latest information on new products, packages and promo's. And while you're there don't forget to check out our Club VocoPro for Karaoke news and events, chat rooms, club directories and even a Service directory!

We look forward to hearing you sound like a PRO, with VocoPro, your ultimate choice in Karaoke entertainment.

FOR YOUR RECORDS

Please record the model number and serial number below, for easy reference, in case of loss or theft. These numbers are located on the rear panel of the unit. Space is also provided for other relevant information

Model Number _____

Serial Number _____

Date of Purchase _____

Place of Purchase _____

Listening for a lifetime

Selecting fine audio equipment such as the unit you've just purchased is only the start of your musical enjoyment. Now it's time to consider how you can maximize the fun and excitement your equipment offers. VocoPro and the Electronic Industries Association's Consumer Electronics Group want you to get the most out of your equipment by playing it at a safe level. One that lets the sound come through loud and clear without annoying blaring or distortion and, most importantly, without affecting your sensitive hearing.

Sound can be deceiving. Over time your hearing 'comfort level' adapts to a higher volume of sound. So what sounds 'normal' can actually be loud and harmful to your hearing. Guard against this by setting your equipment at a safe level BEFORE your hearing adapts.

To establish a safe level:

- Start your volume control at a low setting.
- Slowly increase the sound until you can hear it comfortably and clearly, and without distortion.

Once you have established a comfortable sound level:

- Set the dial and leave it there.
- Pay attention to the different levels in various recordings.

Taking a minute to do this now will help to prevent hearing damage or loss in the future. After all, we want you listening for a lifetime.

Used wisely, your new sound equipment will provide a lifetime of fun and enjoyment. Since hearing damage from loud noise is often undetectable until it is too late, this manufacturer and the Electronic Industries Association's Consumer Electronics Group recommend you avoid prolonged exposure to excessive noise. This list of sound levels is included for your protection.

Some common decibel ranges:

Level	Example
30	Quiet library, Soft whispers
40	Living room, Refrigerator, Bedroom away from traffic
50	Light traffic, Normal Conversation
60	Air Conditioner at 20 ft., Sewing machine
70	Vacuum cleaner, Hair dryer, Noisy Restaurant
80	Average city traffic, Garbage disposals, Alarm clock at 2 ft.

The following noises can be dangerous under constant exposure:

Level	Example
90	Subway, Motorcycle, Truck traffic, Lawn Mower
100	Garbage truck, Chainsaw, Pneumatics drill
120	Rock band concert in front of speakers
140	Gunshot blast, Jet plane
180	Rocket launching pad

-Information courtesy of the Deafness Research Foundation

Before getting started

Thank you for purchasing the DA-8808VE Digital Karaoke Amplifier/Mixer with Vocal Enhancer. The DA-8808VE will provide years of reliability and high quality entertainment for you if used properly. Please read this manual carefully before using your DA-8808VE to ensure best performance.

Unpacking the DA-2808VE

Carefully remove the DA-8808VE from its carton. It is recommended that you store the original packaging materials in case you need to ship this equipment for any reason.

Be sure you have the following parts and components included with your DA-8808VE:

ITEMS:	QUANTITY:
DA-2808VE	1
Stereo RCA Patch Cable	1
Remote Control	1
AAA Batteries	2
AC Power Cable	1

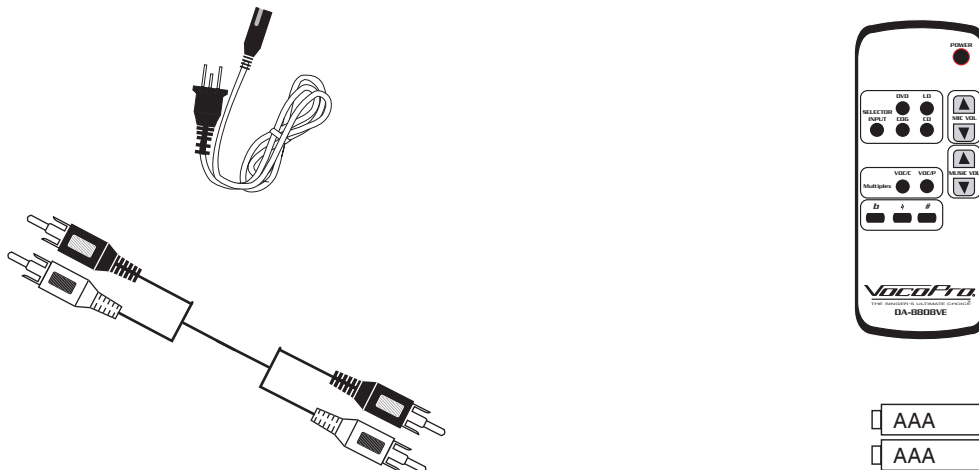
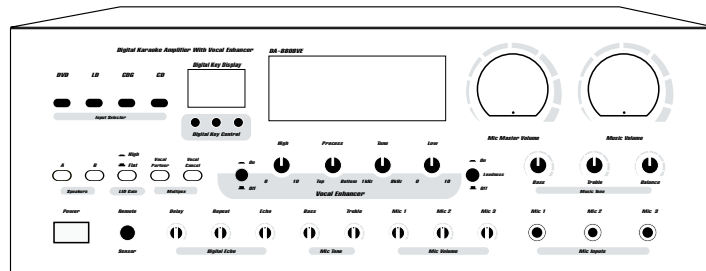

Getting connected

Connecting input source players to the DA-8808VE

The DA-8808VE has stereo paired RCA inputs labeled for RCA stereo audio output from CD, CDG, LD and DVD players and three VIDEO inputs for corresponding video signals from CDG, LD and DVD players. Any other audio device with RCA stereo output such as a cassette player can be connected to these inputs. also. The device associations are for reference only.

1. Use paired RCA stereo cables to output audio signal from your players to the corresponding DA-8808VE CD, CDG, LD and DVD AUDIO INPUTS. Any other audio device with RCA stereo output such as a cassette player can be connected to these inputs. also.

2. Connect the video outputs from your respective players to the DA-8808VE's CDG, LD and DVD VIDEO INPUTS . Use RCA style video cables (usually coded in yellow) to carry the signal that will display Karaoke graphics and video to TVs or other monitor devices when output from the DA-8808VE (see Connecting TVs/ Monitors).

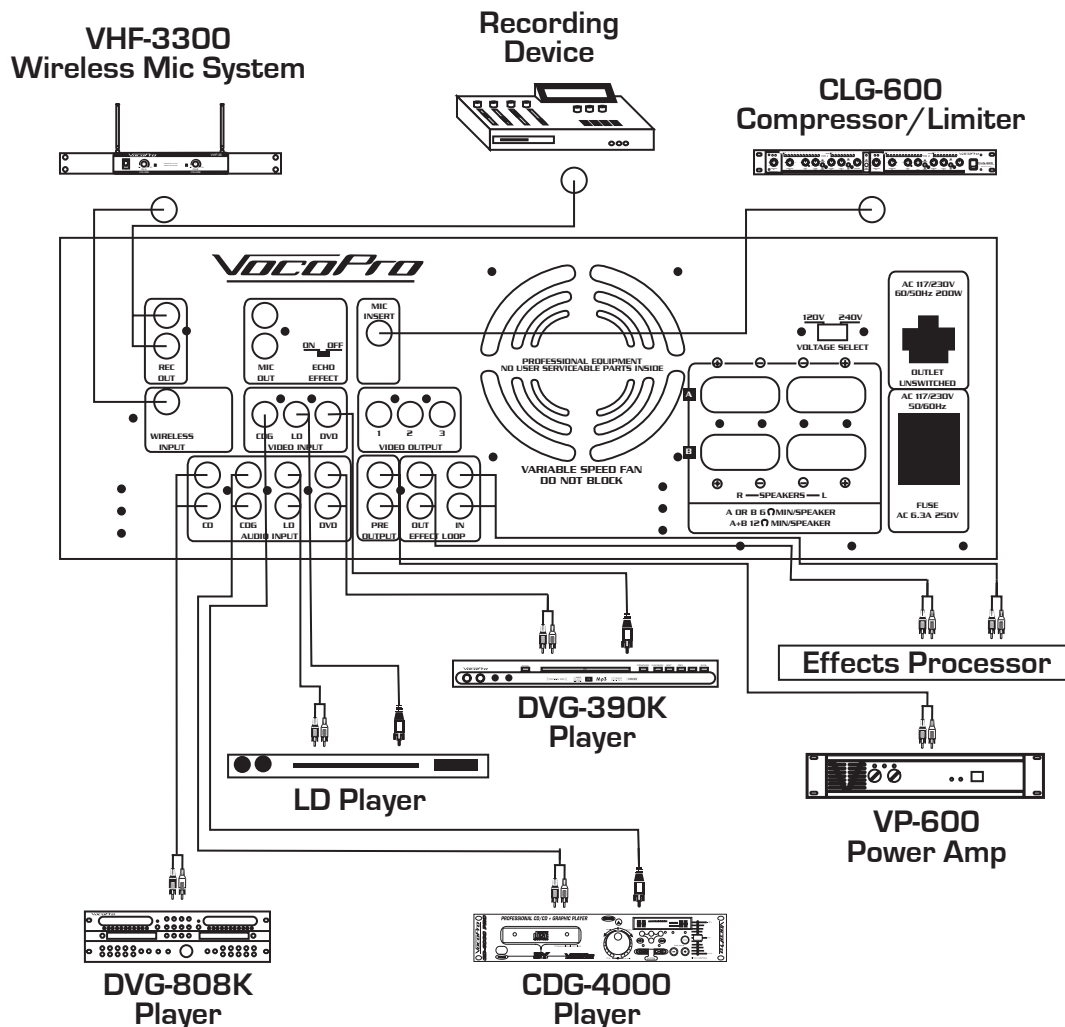

Getting connected continued

Connecting TVs/Monitors to the DA-8808VE

The DA-8808VE has three VIDEO OUTPUT jacks which send video and/or decoded CD+G graphics patched from your players to TVs and other video monitor devices. This enables multiple TV configurations for performers to enjoy and KJs and VJs to program a set.

1. Connect RCA style video cables from VIDEO OUTPUT jacks 1, 2 and 3 on the DA-8808VE to the VIDEO INPUT jack on your TV or other monitor. You may need to manually switch your TV to video mode, while some models automatically switch when a video signal is detected. On most TVs, the INPUT jack is labeled AUX or VIDEO.

-If the TV does not have a VIDEO IN jack, you may be able to connect the video cable to the VIDEO INPUT of a VCR or DVD player and connect the RF OUTPUT on the VCR or DVD player to the TV ANTENNA INPUT jack.

-If you do not have a VCR or DVD player, you will need to use an RF Modulator to make the adaption between jacks. RF Modulators are easy to find in the electronics section of many stores.

Rear of DA-8808VE

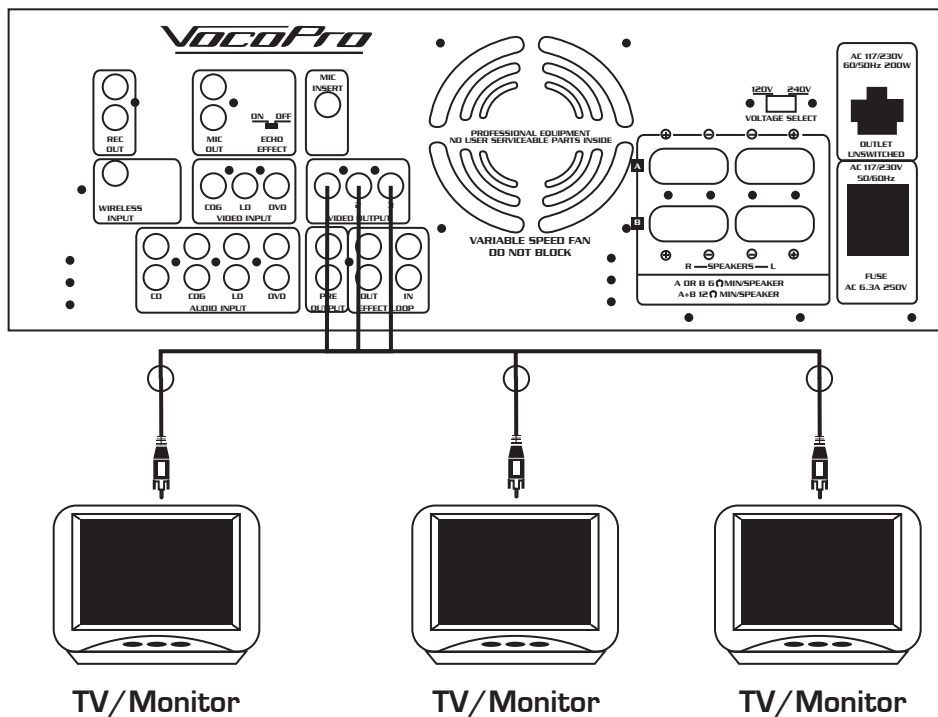

Front panel descriptions and functions

1. POWER - Use this button to turn the DA-8808VE ON or OFF.

2. INPUT SELECTOR - These 4 buttons allow you to select between DVD, LD, CDG and standard CD player output to the DA-8808VE. This allows the DA-8808VE to differentiate between all the related source AUDIO INPUT options available on the back panel.

3. KEY CONTROL - You can adjust the key of your source music in half-step increments to match the natural range of your voice using the KEY CONTROL buttons. To flat (b) or lower the key, press the left KEY CONTROL button. To sharp (#) or raise the key, press the right button. To return to the original key of the music input source, press the center button. You will see the DIGITAL KEY DISPLAY reflect the number of steps you have increased or decreased displayed as numerals with +/-, or 0 for the original key.

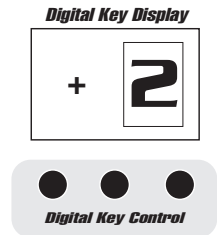

4. LED METER - The LED METER displays stereo output levels for the DA-2808VE mix. The optimal level for a clean, undistorted signal at high output is to show only occasional peaking in the red LED range. Lower the MUSIC VOLUME and MIC MASTER VOLUME if red LEDs are frequent.

5. MIC MASTER VOLUME - This control adjusts the mixed output level for MIC 1, MIC 2 and MIC 3. Turn clockwise to increase and counter-clockwise to decrease the MIC VOLUME.

6. MUSIC VOLUME - This control adjusts the output level for whichever player connected to an AUDIO INPUT is assigned with the INPUT SELECTOR.

7. SPEAKERS A/B - These buttons switch between 2 sets of SPEAKER OUTPUT.

8. LED GAIN - Select between a HIGH or FLAT LED display mode for different effect and visibility.

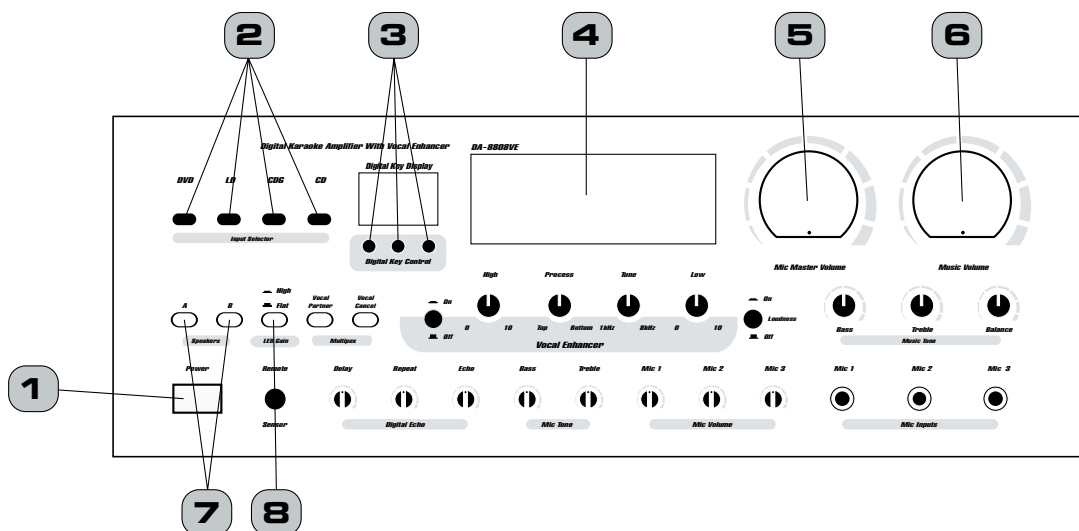

Front panel descriptions and functions continued

9. VOCAL CANCEL/VOCAL PARTNER - With Multiplex media, lead vocals and music are recorded in separate left and right stereo channels. When VOCAL CANCEL is selected, the LED will illuminate and the lead vocal channel will be removed, leaving only a duplicated instrumental track to left and right. When VOCAL PARTNER is pressed, LED will illuminate and the vocal track will only be activated while there is no microphone input. In other words, while the Karaoke singer is performing, the vocals will never drop entirely out, keeping the action going.

VOCAL ENHANCER

Because the DA-8808VE allows you to “TUNE” the frequency and mix, or “PROCESS” of your microphone output, it is a more powerful EQ tool than standard Bass and Treble controls.



10. VOCAL ENHANCER ON/OFF - This button activates or deactivates the VOCAL ENHANCER processor feature. Try using this button to do an A/B comparison of a processed and unprocessed signal while someone sings into the microphone. This is helpful for fine-tuning and system diagnostics.

11. HIGH - Similar to a Treble control, this boosts the HIGH frequencies in your EQ, from 0 to 10.

12. PROCESS - This control is similar to a Balance control for the EQ, where you can select between a mix predominantly “High end” mix and a bassier “Low end” mix.

13. TUNE - This control allows you fine tune specific frequencies more precisely, by setting the lower cutoff frequency of the high-pass filter between 1kHz and 8kHz. Fortunately, you can still use it without understanding what that means. The best way to use this control is by adjusting it while someone is singing into the microphone to find that “sweet spot” where the EQ sounds clean (not harsh, without distortion) and well-balanced.

14. LOW - Similar to a Bass control, this boosts the LOW frequencies in your EQ, from 0 to 10.

15. LOUDNESS ON/OFF - For an instant Volume/Gain, the LOUDNESS button is an easy way to improve your mix when you need an extra boost. Perfect for varying volume controls between tracks or singers.

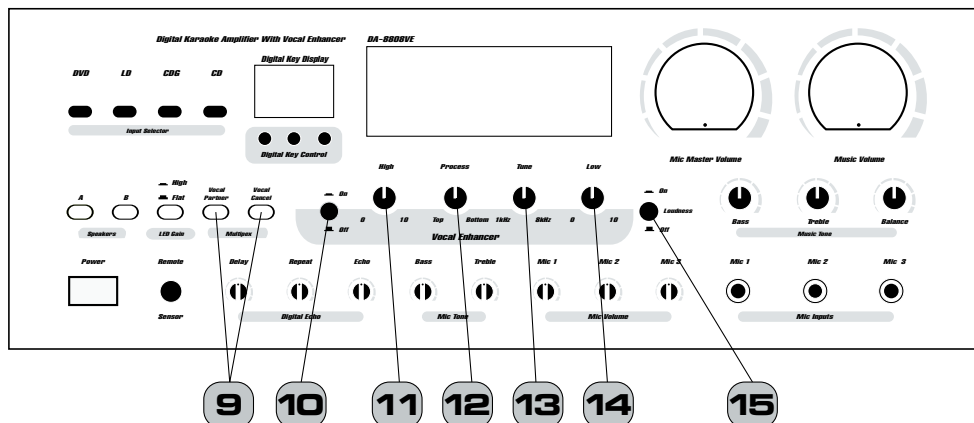

Front panel descriptions and functions continued

MUSIC TONE controls

16. BASS/TREBLE - The BASS control adjusts the low end of your source music and the TREBLE control adjusts the high end.

17. BALANCE - This control determines the Left to Right stereo BALANCE between speaker outputs.

18. REMOTE SENSOR - When operating the DA-8808VE with the Remote Control, direct the Remote towards this SENSOR within 23 feet. Maintain a line of sight between Remote and REMOTE SENSOR clear of obstacles to prevent signal deflection.

DIGITAL ECHO

19. DELAY - This control adjusts the length of time for each ECHO interval, or REPEAT. Rotating the DELAY control clockwise will increase the DELAY, creating the effect of more "space."

20. REPEAT - This control adjusts the number of ECHO repeats applied to the signal until the effect decays, or fades out.

21. ECHO - This control is the overall level for the ECHO effect. Rotate clockwise to increase the amount of ECHO effect applied to the signal, and counter-clockwise to decrease.

22. MIC TONE - The BASS control adjusts the low end of the microphone mix from MIC 1, 2 and 3, while the TREBLE control adjusts the high end of the mix.

23. MIC VOLUME - These level controls for MIC 1, 2 and 3 should be adjusted individually to get the best mix when multiple performers are singing. Rotate clockwise to increase and counter-clockwise to decrease VOLUME for each mic.

24. MIC 1, 2, 3 INPUTS - Connect your 1/4" cabled microphones here.

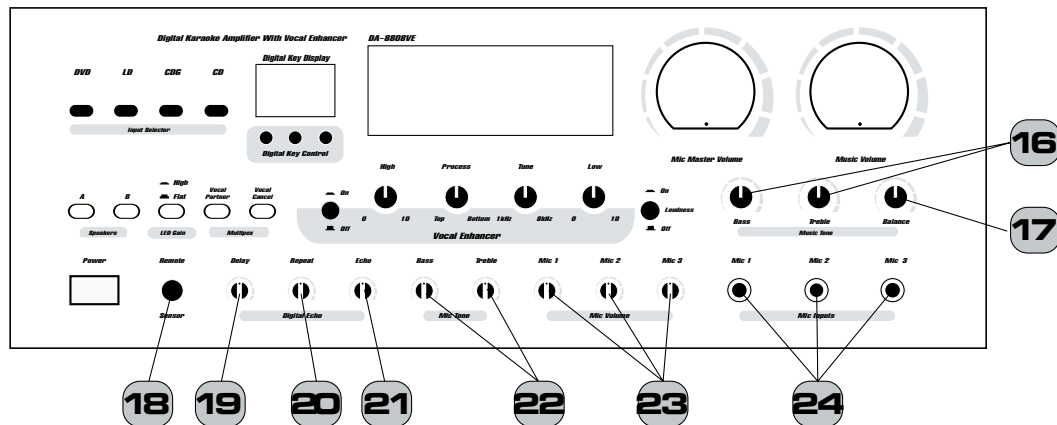

Rear panel descriptions and functions

1. **RECORD OUT** - These RCA output jacks are designed for connection to a recording device such as a cassette deck, CD burner or hard disc recorder. Output from the RECORD OUT jacks is line-level, so the MASTER VOLUME controls will not affect the output signal to your recording device.
2. **MIC OUT** - Using these RCA output jacks, you can isolate your mic mix, without the source music audio input, for output to an external device.
3. **ECHO EFFECT ON/OFF** - This switch will assign ECHO to the mic mix output through MIC OUT (#2).
4. **MIC INSERT** - This jack is used for connection of an outboard processor such as a compressor using only a single 1/4" TRS (Tip = send, Ring = return, Sleeve = signal ground).
5. **WIRELESS INPUT** - This input is dedicated for the output from wireless microphone systems.
6. **VIDEO INPUT** - Connect the RCA style video output from your CDG, LD, and DVD player to the respective jacks in this section.
7. **VIDEO OUTPUT** - Connect RCA style video cables from these outputs to the video inputs of your TV or other video monitor device.
8. **VOLTAGE SELECTOR** - Using this switch you can select between 120V and 240V power settings
9. **AC POWER OUTLET** - This unswitched AC outlet is for providing power to an external device. NOTE: DO NOT CONNECT A DEVICE THAT IS DESIGNED FOR 240V USE OR HAS A POWER CONSUMPTION LEVEL HIGHER THAN 200W.

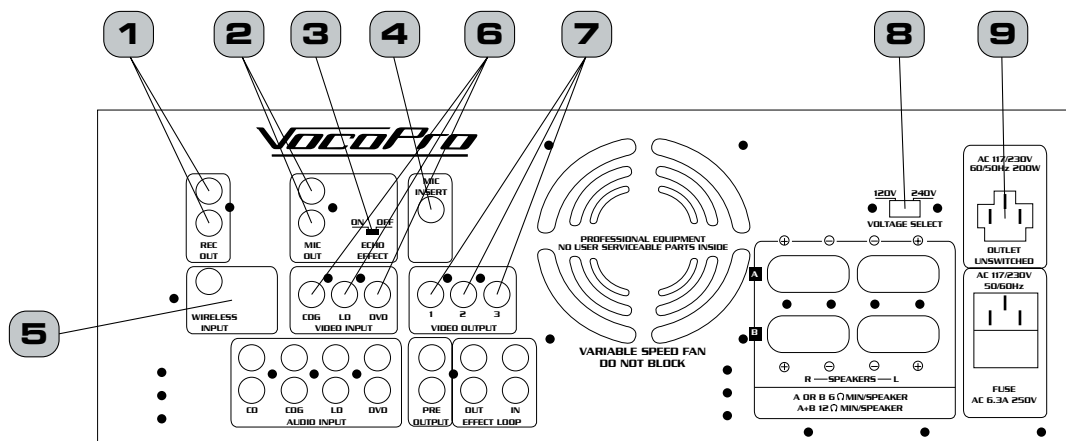

Rear panel descriptions and functions continued

10. AUDIO INPUT - Use these inputs for connecting CD, CDG, LD, DVD or other players and other music sources using RCA cables. The labels here are for reference only. So, you can connect a cassette player to the LD input, for example, and get the same results.

11. PRE OUTPUT - These jacks are designed for connection to external power amplifiers. Output signals from the PRE OUTPUT are sent before the DA-8808VE amplification stage. This allows you to power your speaker system from a separate amplifier rather than the speaker output from the DA-8808VE.

12. EFFECT LOOP - These jacks are necessary to carry the stereo signal for the DA-8808VE's internal effects to left and right channel output. The 2 Loop Bars which are already installed in the EFFECT LOOP IN and OUT jacks of the DA-8808VE allow the EFFECT LOOP to operate internally. However, if you wish to bypass the internal effects, these jacks enable you to connect external effects devices to the DA-8808VE in a stereo loop.

If you prefer to connect external effects, use RCA cables to connect from the EFFECT LOOP OUT jack pictured here to your external effect unit EFFECT LOOP input, and then out from the component to the EFFECT LOOP IN of the DA-8808VE. This creates a continuous stereo loop.

13. SPEAKERS OUTPUT A & B - You can connect up to 4 different speakers between SPEAKERS OUTPUT A and B. Use "banana plug" style speaker cables for left and right of each pair. These can be powered simultaneously or in individual pairs using the SPEAKERS A/B buttons on the front panel (#7).

14. AC POWER CABLE TERMINAL - Connect the included AC Power Cable here and the other end to an electrical outlet.

15. FUSE - This plastic cover is the housing for the DA-8808VE's fuse. Use only FUSE type AC 6.3A, 250V when replacing the fuse.

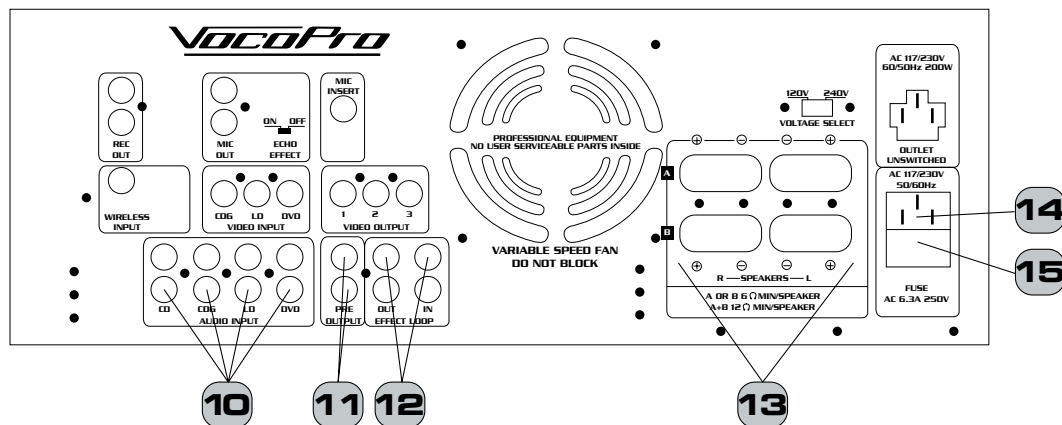

Remote control descriptions and functions

The maximum operating distance between the Remote Control and the REMOTE SENSOR is approximately 23 feet. If the effective distance of the Remote decreases, replace the batteries. To install new batteries, remove the battery compartment lid on the back of the Remote and insert two AAA batteries with polarities aligned.

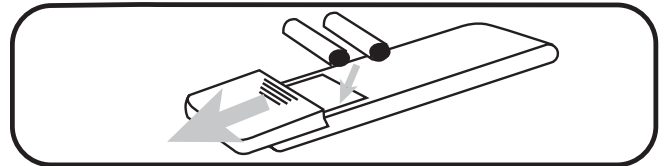
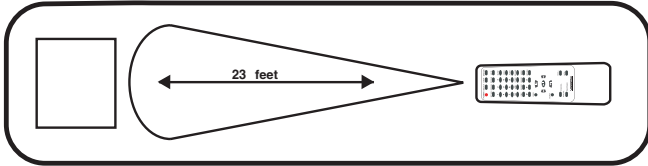

1. POWER - This remote control button turns the DA-8808VE ON/OFF

2. INPUT SELECTOR - These buttons switch between the signals from CD, CDG, LD and DVD inputs. Whichever player or source music is connected to these respective AUDIO INPUTS will be activated with these keys.

3. MIC VOLUME - Use the ▲ to raise the MIC MASTER VOLUME (front panel, #5) and the ▼ to lower this mixed MIC MASTER VOLUME. You will see the controls on the DA-8808VE move as you make adjustments using the remote keys.

4. MUSIC VOLUME - Use the ▲ to raise the MUSIC VOLUME (front panel, #6) and the ▼ to lower the MUSIC VOLUME. You will see the controls on the DA-8808VE move as you make adjustments using the remote keys.

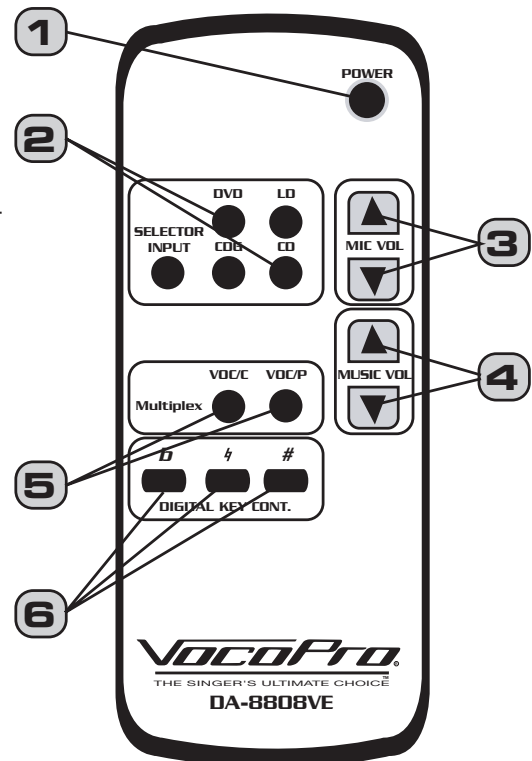

5. VOCAL CANCEL/VOCAL PARTNER - With Multiplex media, lead vocals and music are recorded in separate left and right stereo channels. When the VOCAL CANCEL (VOC/C) button on the remote is selected, the LED will illuminate and the lead vocal channel will be removed, leaving a duplicated instrumental track to left and right only. When VOCAL PARTNER (VOC/P) is pressed, the LED will illuminate and the vocal track will only be activated only while there is no microphone input. In other words, while the Karaoke singer is performing, the vocals will never drop entirely out, keeping the action going.

6. DIGITAL KEY CONTROL - You can adjust the key of your source music in half-step increments to match the natural range of your voice using the KEY CONTROL buttons on the remote control. To flat (b) or lower the key, press the left KEY CONTROL button. To sharp (#) or raise the key, press the right button. To return to the original key of the music input source, press the center button. You will see the DIGITAL KEY DISPLAY reflect the number of steps you have increased or decreased displayed as numerals with +/-, or 0 for the original key.

Advanced Operations

Working with vocals using external effects devices

Often, vocalists use external effects such as Echo, Reverb and Key Control. While enhancing vocals, these effects can also limit the signal's sound quality. The DA-8808VE's Vocal Enhancer can help "clean up" the vocal signal after effects have been applied.

The frequency bandwidth of most vocals is approximately 300Hz - 6kHz. The DA-8808VE can improve the sound quality of frequencies across this range so that microphone input has a more natural and clean sound. Nuances of your vocals can be emphasized without affecting the overall sound. Since every voice is different, we recommend that you experiment with different settings to find the sound which best suits your preferences.

Using the Vocal Enhancer

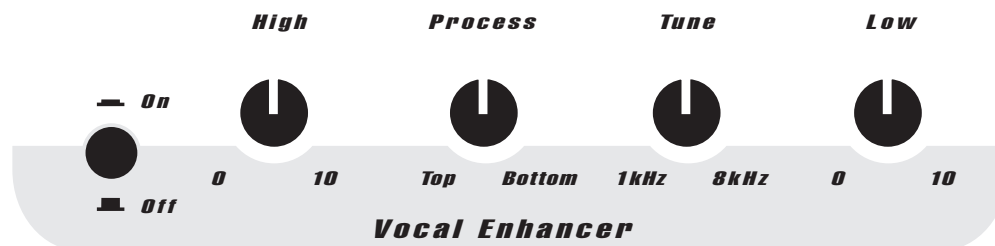

Use of the Vocal Enhancer will increase your speaker system's acoustic performance and its audible level in a room. This is particularly effective in environments with difficult acoustics. When using the DA-8808VE's Vocal Enhancer, MIC MASTER VOLUME level may need to be adjusted as perceived volume increases.

1. Connect a microphone with a 1/4" cable to MIC INPUT 1, 2 or 3.
2. Select the VOCAL ENHANCER to the ON (in) position.
3. Start with the HIGH, PROCESS, TUNE and LOW controls at their center positions.
4. Adjust the HIGH and LOW clockwise or counterclockwise until you find a comfortable balance where they are both equally audible while neither is causing feedback or distortion of the signal.
5. Now adjust the TUNE controls until you reach the desired cutoff frequency for the high-pass filter. Ultimately, you should be able to settle on a "sweet spot" frequency setting that improves the overall tone of your treble and bass without leaving either sounding harsh or dominant in the mix.
6. For further fine tuning, think of the PROCESS control as an overall balance between HIGH, or treble (TOP) and LOW, or bass (BOTTOM). This is a largely a matter of preference, so you should experiment to find the PROCESS setting that best suits your ears.
7. Try an ON/OFF comparison with the VOCAL ENHANCER to get a better idea for how it is improving your tone and to better acquaint yourself with the result of adjusting the controls .

DA-8808VE Specifications

MAXIMUM POWER OUTPUT——— 180W + 180W

AUDIO

MICROPHONE——— 2.5MV/10K Ω

DVD/LD/CDG/CD——— 150MV/50 K Ω

VIDEO

DVD/ LD / CDG —— 1V P-P/75 Ω

FREQUENCY RESPONSE

DVD/ LD / CDG —— 20Hz-20kHz \pm 3db

TONE CONTROL (MUSIC / MIC)

BASS——— \pm 10db / \pm 8db (100Hz) \pm 3db

TREBLE —— \pm 10db / \pm 8db (10KHz) \pm 3db

LOUDNESS CONTROL

100Hz——— +8db / \pm 3db

10KHz——— +5db / \pm 3db

PROCESSOR

VOCAL ENHANCER——— HIGH. PROCESS. TUNE. LOW CONTROL

ECHO DELAY TIME——— 100 msec - 200 msec

KEY CONTROL RANGE——— +6/-6 KEY INTERVALS (13 STEPS)

SIGNAL TO NOISE RATIO——— >50db

POWER SUPPLY, OTHER

POWER REQUIREMENTS——— AC 120V/240V 60Hz/50Hz

POWER CONSUMPTION——— 490 WATT

AC OUTLET

UNSWITCHED——— 1 (MAX 200W)

DIMENSIONS

(W x D x H):——— 430 x 385 x 165 (mm)

ACCESSORIES

AC POWER CORD —— 1

RCA CABLES —— 2

OPERATING INSTRUCTIONS —— 1

REMOTE CONTROL —— 1

BATTERIES (UM-4) —— 2

WARRANTY CARD —— 1

VocoPro[®]

THE SINGER'S ULTIMATE CHOICE[™]

