

VocoPro[®]

THE SINGER'S ULTIMATE CHOICE[™]

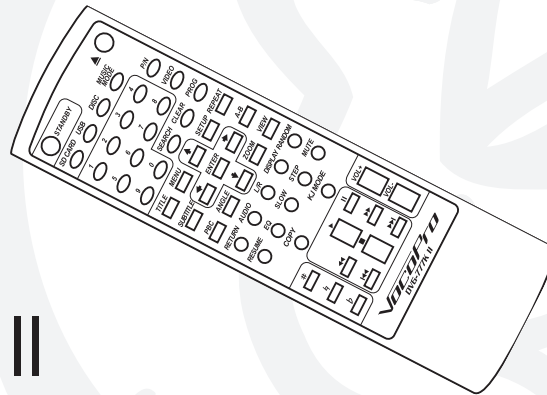

DVG-777K II

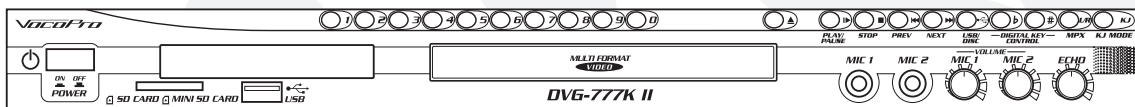

Multi-Format USB/DVD/CD+G Karaoke Player

o w n e r ' s m a n u a l

Table of Contents

Safety Instructions.....	3
FCC Information	4
Welcome	5
Features and Specifications	6
Getting Started	7
• Warranty Information	7
• Package Contents.....	7
Getting Connected.....	8
• Audio Connections	8
• Video Connections	10
• USB Device Connection	12
• SD/Mini SD card connection.....	12
General Operations.....	13
• DVD Operations.....	17
• Mp3, AVI and Media File Operations	18
• Copying Music to SD card or USB	19
Descriptions and Functions	20
• Front Panel.....	20
• Rear Panel	21
• Remote Control	22
Setup Menu	24
• System Setup Menu	24
• Audio Setup Menu	25
• Video Setup Menu.....	25
• Speaker Setup Menu.....	25
Troubleshooting	27

Safety Instructions



CAUTION
RISK OF SHOCK



CAUTION: To reduce the risk of electric shock, do not remove cover (or back). No user-serviceable parts inside. Only refer servicing to qualified service personnel.

Explanation of Graphical Symbols



The lightning flash & arrowhead symbol, within an equilateral triangle, is intended to alert you to the presence of danger.



The exclamation point within an equilateral triangle is intended to alert you to the presence of important operating and servicing instructions.

WARNING

To reduce the risk of fire or electric shock, do not expose this unit to rain or moisture.

1. Read Instructions - All the safety and operating instructions should be read before the appliance is operated.

2. Retain Instructions - The safety and operating instructions should be retained for future reference.

3. Heed Warnings - All warnings on the appliance and in the operating instructions should be adhered to.

4. Follow Instructions - All operating and use instructions should be followed.

5. Attachments - Do not use attachments not recommended by the product manufacturer as they may cause hazards.

6. Water and Moisture - Do not use this unit near water. For example, near a bathtub or in a wet basement and the like.

7. Carts and Stands - The appliance should be used only with a cart or stand that is recommended by the manufacturer.

7 A. An appliance and cart combination should be moved with care. Quick stops, excessive force, and uneven surfaces may cause an overturn.



8. Ventilation - The appliance should be situated so its location does not interfere with its proper ventilation. For example, the appliance should not be situated on a bed, sofa, rug, or similar surface that may block the ventilation slots.

9. Heat - The appliance should be situated away from heat sources such as radiators, heat registers, stoves, or other appliances (including amplifiers) that produce heat.

10. Power Sources - The appliance should be connected to a power supply only of the type described in the operating instructions or as marked on the appliance.

11. Grounding or Polarization - Precautions should be taken so that the grounding or polarization means of an appliance is not defeated.

12. Power-Cord Protection - Power-supply cords should be routed so that they are not likely to be walked on or pinched by items placed upon or against them, paying particular attention to cords at plugs, convenience receptacles, and the point where they exit from the appliance.

13. Cleaning - Unplug this unit from the wall outlet before cleaning. Do not use liquid cleaners or aerosol cleaners. Use a damp cloth for cleaning.

14. Power lines - An outdoor antenna should be located away from power lines.

15. Nonuse Periods - The power cord of the appliance should be unplugged from the outlet when left unused for a long period of time.

16. Object and Liquid Entry - Care should be taken so that objects do not fall and liquids are not spilled into the enclosure through openings.

17. Damage Requiring Service - The appliance should be serviced by qualified service personnel when:

- A. The power supply cord or plug has been damaged; or
- B. Objects have fallen into the appliance; or
- C. The appliance has been exposed to rain; or
- D. The appliance does not appear to operate normally or exhibits a marked change in performance; or
- E. The appliance has been dropped, or the enclosure damaged.

18. Servicing - The user should not attempt to service the appliance beyond that described in the operating instructions. All other servicing should be referred to qualified service personnel.

Note:

To CATV system installer's (U.S.A.): This reminder is provided to call the CATV system installer's attention to Article 820-40 of the NEC that provides guidelines for proper grounding and, in particular, specifies that the cable ground shall be connected as close to the point of cable entry as practical.

FCC information (U.S.A.)

1. IMPORTANT NOTICE: DO NOT MODIFY THIS

UNIT!: This product, when installed as indicated in the instructions contained in this manual, meets FCC requirements. Modifications not expressly approved by Vocopro may void your authority, granted by the FCC, to use this product.

2. IMPORTANT: When connecting this product to accessories and/or another product use only high quality shielded cables. Cable(s) supplied with this product **MUST** be used. Follow all installation instructions. Failure to follow instructions could void your FCC authorization to use this product in the U.S.A.

3. NOTE: This product has been tested and found to comply with the requirements listed in FCC Regulations, Part 15 for Class "B" digital devices. Compliance with these requirements provides a reasonable level of assurances that your use of this product in a residential environment will not result in harmful interference with other electronic devices. This equipment generates/uses radio frequencies and, if not installed and used according to the instructions found in the owner's manual, may cause interference harmful to the operation of other electronic devices. Compliance with FCC regulations does not guarantee that interference will not occur in all installations. If this product is found to be the source of interference, which can be determined by turning the unit "Off" and "On", please try to eliminate the problem by using one of the following measures:

Relocate either this product or the device that is being affected by the interference.

Use power outlets that are on different branch (circuit breaker or fuse) circuits or install AC line filter(s).

In the case of radio or TV interference, relocate/reorient the antenna. If the antenna lead-in is 300-ohm ribbon lead, change the lead-in to coaxial type cable.

If these corrective measures do not produce satisfactory results, please contact your local retailer authorized to distribute Vocopro products. If you can not locate the appropriate retailer, please contact Vocopro, 1728 Curtiss Court, La Verne, CA 91750.

CAUTION

The apparatus is not disconnected from the AC power source so long as it is connected to the wall outlet, even if the apparatus itself is turned off. To fully insure that the apparatus is indeed fully void of residual power, leave unit disconnected from the AC outlet for at least fifteen seconds.

CAUTION:

READ THIS BEFORE OPERATING YOUR UNIT

1. To ensure the finest performance, please read this manual carefully. Keep it in a safe place for future reference.

2. Install your unit in a cool, dry, clean place - away from windows, heat sources, and too much vibration, dust, moisture or cold. Avoid sources of hum (transformers, v motors). To prevent fire or electrical shock, do not expose to rain and water.

3. Do not operate the unit upside-down.

4. Never open the cabinet. If a foreign object drops into the set, contact your dealer.

5. Place the unit in a location with adequate air circulation. Do not interfere with its proper ventilation; this will cause the internal temperature to rise and may result in a failure.

6. Do not use force on switches, knobs or cords. When moving the unit, first turn the unit off. Then gently disconnect the power plug and the cords connecting to other equipment. Never pull the cord itself.

7. Do not attempt to clean the unit with chemical solvents: this might damage the finish. Use a clean, dry cloth.

8. Be sure to read the "Troubleshooting" section on common operating errors before concluding that your unit is faulty.

9. This unit consumes a fair amount of power even when the power switch is turned off. We recommend that you unplug the power cord from the wall outlet if the unit is not going to be used for a long time. This will save electricity and help prevent fire hazards. To disconnect the cord, pull it out by grasping the plug. Never pull the cord itself.

10. To prevent lightning damage, pull out the power cord and remove the antenna cable during an electrical storm.

11. The general digital signals may interfere with other equipment such as tuners or receivers. Move the system farther away from such equipment if interference is observed.

NOTE:

Please check the copyright laws in your country before recording from records, compact discs, radio, etc. Recording of copyrighted material may infringe copyright laws.

Voltage Selector (General Model Only)

Be sure to position the voltage selector to match the voltage of your local power lines before installing the unit.

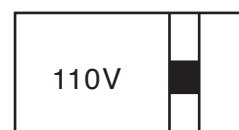

Welcome



And Thank you for purchasing the **DVG-777K II** from VocoPro, your ultimate choice in Karaoke entertainment! With years of experience in the music entertainment business, VocoPro is a leading manufacturer of Karaoke equipment, and has been providing patrons of bars, churches, schools, clubs and individual consumers the opportunity to sound like a star with full-scale club models, in-home systems and mobile units. All our products offer solid performance and sound reliability, and to reinforce our commitment to customer satisfaction, we have customer service and technical support professionals ready to assist you with your needs. We have provided some contact information for you below.

VocoPro

1728 Curtiss Court
La Verne, CA 91750

Toll Free: 800-678-5348

TEL: 909-593-8893

FAX: 909-593-8890

VocoPro Company Email Directory

Customer Service & General Information

info@vocopro.com

Tech Support

techsupport@vocopro.com

Remember Our Website

Be sure to visit the VocoPro website **www.vocopro.com** for the latest information on new products, packages and promos. And while you're there don't forget to check out our Club VocoPro for Karaoke news and events, chat rooms, club directories and even a KJ Service directory!

We look forward to hearing you sound like a PRO, with VocoPro, your ultimate choice in Karaoke entertainment.

FOR YOUR RECORDS

Please record the model number and serial number below, for easy reference, in case of loss or theft. These numbers are located on the rear panel of the unit. Space is also provided for other relevant information

Model Number _____

Serial Number _____

Date of Purchase _____

Place of Purchase _____

Features and Specifications

Features

- Multi-format disc player reads DVD, CD, CD+G, Mp3, Mp4, HDCD and VCD
- USB, SD and MiniSD card playback
- Hard drive playback supports FAT/FAT 32 format
- Copy Mode creates mp3 versions of your CD tracks
- Two ¼" microphone input channels with individual volume controls
- KJ Mode function with single and cue modes
- 5.1 channel surround sound
- Direct Track Access
- Digital Echo gives vocals that hard-to-find professional sound
- Full-function remote control
- PAL/NTSC compatible for worldwide use
- LED Display window
- Audio Outputs: 5.1 Channel RCA surround sound, L/R RCA Stereo (music only), 2 L/R RCA Karaoke (music and microphone), Digital Coaxial (music only), Digital Optical (music only)
- Video Outputs: RCA video, Y/Pb/Pr, VGA, SCART

Specifications

Power requirements.....	100V/240V AC, 50/60Hz
Power consumption	25W
Disc compatibility	DVD, Mp4, VCD 1.0-3.0, Mp3, SVCD, CD+G, CD, JPEG, CD-R/RW*, DVD+R/-R/RW*
Disc size requirements	Diameter: 120mm/80mm
Video format	NTSC, PAL, Multi System, 480P, 576P, 720P
Video output type	Video, S-Video, VGA, SCART, YUV, YPbPr
Video output level.....	CVBS: 1Vp-p 75Ω
USB jack	USB1.1
Remote distance	22 feet maximum**, 30° angle
Audio output format	Stereo, 5.1CH, optical, and coaxial
DVD frequency response.....	20-20kHz
DVD S/N ratio	80dB
DVD harmonic distortion.....	0.3%
Karaoke frequency response	20-20kHz
Karaoke S/N ratio	70dB
Echo level	10 levels
Total harmonic distortion	0.5%

*Some burned CDs and DVDs may not play properly on the DVG-777K II. If this is the case, try using a different brand of disc or a different disc-burning program.

**Actual maximum distance may vary

Package Contents

When unpacking your DVG-777K II we recommend that you keep the original receipt or invoice, box and packing materials in case the product ever needs to be shipped for warranty repair or any other purpose.

Warranty Information

The DVG-777K II is covered under a 1-Year Limited Warranty. For detailed warranty information please visit

www.vocopro.com/warranty_standard.html

Extended Limited Warranty

Extended Warranties are also available and can be purchased directly from VocoPro. Visit

www.vocopro.com/warranty_extended.html

for information and purchasing of our Silver and Gold Extended Limited Warranties.

Service Centers

For a list of U.S. and International Authorized VocoPro Service Centers visit

www.vocopro.com/frm_service.html

Package Contents

Before using the DVG-777K II make sure the following accessories are included:

- 1 DVG-777K II Multi-Format USB/DVD/CD+G Karaoke Player
- 1 Remote Control
- 1 AC Power Cord
- 1 A/V RCA cable (red, white and yellow)
- 2 Rack ears
- 1 Warranty Card

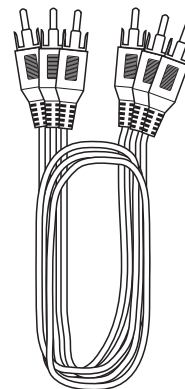
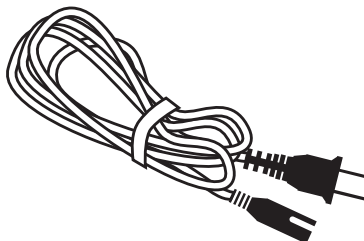
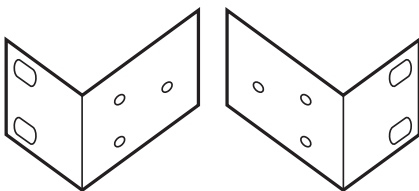
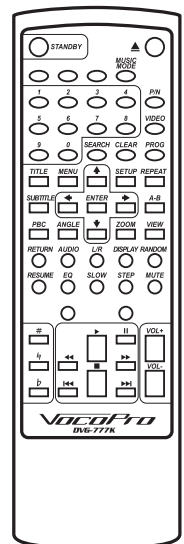
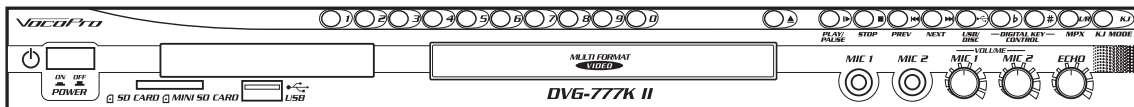

Getting Connected

Audio Connections

Music and Microphone Vocals through the Karaoke Mixed Outputs

The two Karaoke Mixed Output channels allow you to connect vocals and music to up to two separate audio input devices (mixer, amp, power speaker, recording device, etc.).

What you will need:

- 2 RCA L/R (red & white) audio cables
- Up to 2 audio input devices (mixer, amp, power speaker, recording device, etc.)

1. Connect one end of the L/R RCA audio cable to one of the L and R (red & white) RCA Karaoke Mixed Output channels on the DVG-777K II's rear panel
2. Connect the other end of the L/R RCA audio cable to the L/R RCA audio inputs on an audio input device
3. To connect to a second device, follow steps 1 and 2 above, except now using the other Karaoke Mixed Output channel on the DVG-777K II's rear panel

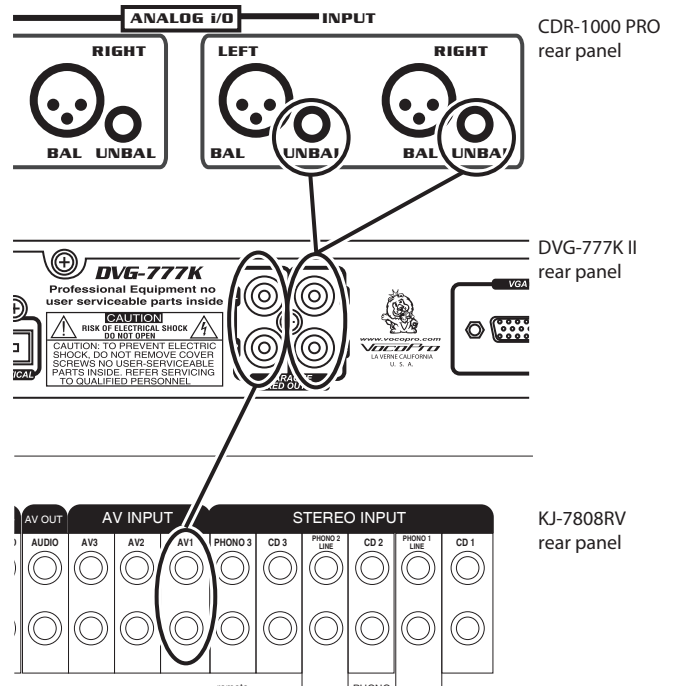

5.1 Audio (Disc audio only, no microphone vocals)

NOTE: Microphone vocals are not present in the 5.1 Channel signal.

Connecting to a 5.1 Surround Sound Receiver (Music only, no microphone vocals)

What you will need:

- 6 RCA-style surround sound cables
- A 5.1 surround sound receiver or amplifier

1. Connect an end of each RCA cable to the FL, FR, CEN, SL, SR, and SW outputs on the rear panel of the DVG-777K II
2. Connect the other end of each RCA cable to the FL, FR, CEN, SL, SR, and SW inputs on a 5.1 CH. Surround Sound receiver or amplifier.

NOTE: The actual inputs may be labeled differently on certain receivers and amplifiers.

- FL - Front Left
- FR - Front Right
- CEN - Center
- SL - Side Left
- SR - Side Right
- SW - Subwoofer

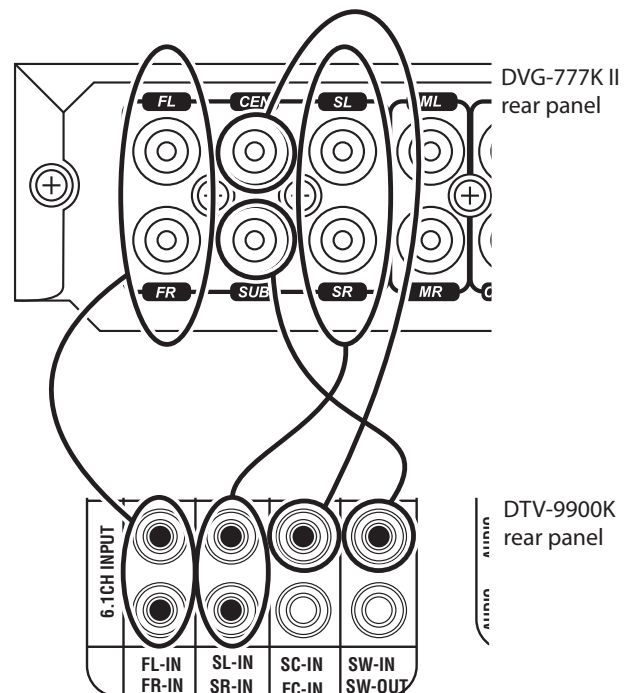

Getting Connected

Connecting Directly to a Powered Subwoofer

The DVG-777K II can be connected directly to a powered subwoofer with an RCA input.

What you will need:

- 1 RCA cable
- A powered subwoofer with an RCA audio input

1. Connect one end of the RCA cable to the SW output on the rear panel of the DVG-777K II
2. Connect the other end of the RCA cable to the RCA input on the powered subwoofer

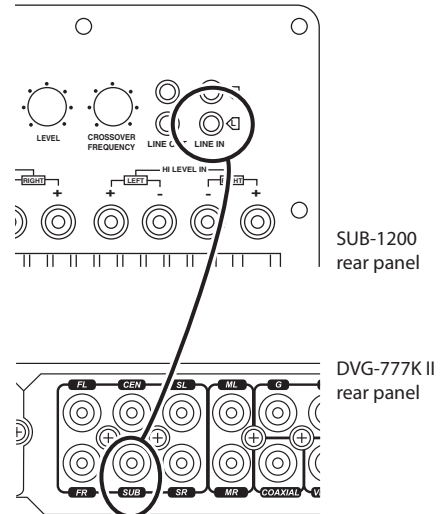

Stereo RCA

Use the ML and MR outputs for connecting audio from the disc player (DVD, CD, VCD, etc) to a stereo input device.

What you will need:

- 1 RCA L/R (red & white) audio cable
- 1 audio input device (mixer, amp, power speaker, recording device, etc.)

1. Connect one end of the L/R RCA audio cable to the ML and MR RCA jacks on the DVG-777K II's rear panel.
2. Connect the other end of the L/R RCA audio cable to the L/R RCA audio inputs on an audio input device.

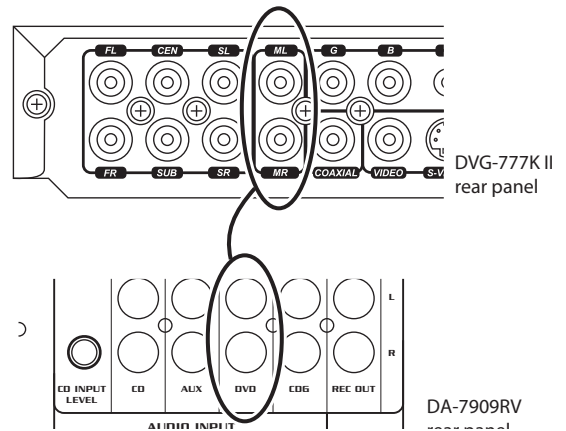

Optical

Use the Optical output for connecting digital audio to a device with an optical input.

What you will need:

- 1 Digital Optical cable
- An audio input device with a Digital Optical audio input jack such as a digital receiver or mixer

1. Connect one end of the Optical cable to the OPTICAL output jack on the rear panel of the DVG-777K II
2. Connect the other end of the Optical cable to an Optical input jack on a receiver, mixer, etc.

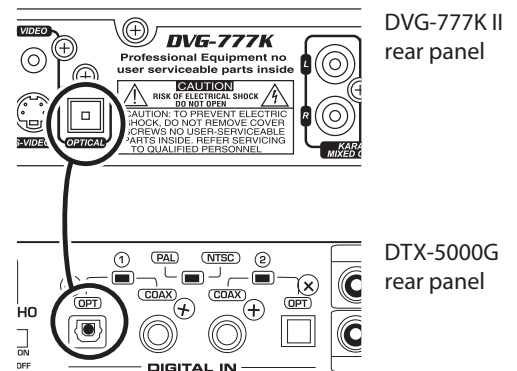

Getting Connected

Coaxial

Use the Coaxial output for connecting digital audio to a device with a coaxial input.

What you will need:

- 1 Digital Coaxial cable**
- An audio input device with a Digital Coaxial audio input jack such as a digital receiver or mixer

1. Connect one end of the Coaxial cable to the COAXIAL output jack on the rear panel of the DVG-777K II
2. Connect the other end of the Coaxial cable to a Coaxial input jack on a receiver, mixer, etc.

** Although it is alright to use standard RCA cables, it is recommended that you use Digital RCA audio cables for optimum digital signal quality.

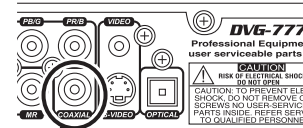

DVG-777K II rear panel

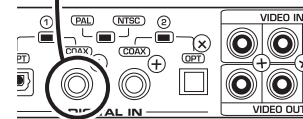

DTX-5000G rear panel

Video Connections

Connecting Video Using the RCA Video Output

What you will need:

- 1 RCA video cable (usually labeled yellow)
- A TV, video monitor or video mixer with an RCA video input

1. Connect one end of the RCA video cable to the yellow RCA VIDEO output on the rear panel of the DVG-777K II
2. Connect the other end of the RCA video cable to an RCA video input jack on a TV, monitor or video mixer

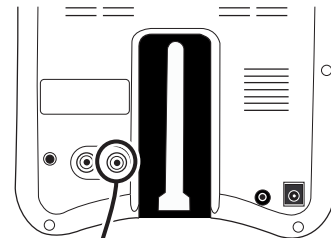

LTV-5 rear panel

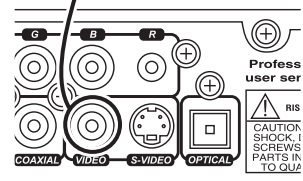

DVG-777K II rear panel

S-Video

What you will need:

- 1 S-Video Cable
- A TV, video monitor or video mixer with an S-Video input

1. Connect one end of the S-Video cable to the S-Video output on the rear panel of the DVG-777K II
2. Connect the other end of the S-Video cable to an S-Video input jack on a TV, monitor or video mixer

NOTE: When using the S-Video output, the DVG-777K II must be set to S-VIDEO output. See "Changing the Video Output Mode" in the Operations section of this manual for detailed instructions on setting the DVG-777K II to S-VIDEO Mode.

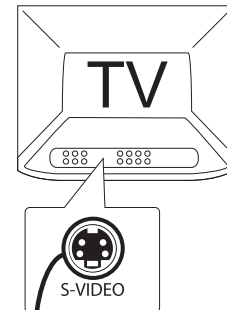

TV or Monitor rear panel

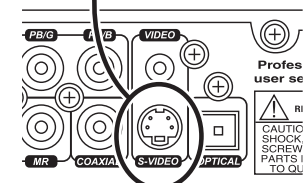

DVG-777K II rear panel

Getting Connected

RGB/Component Video HD Outputs

What you will need:

- 1 RGB cable
- A High-Definition TV with RGB or Component (Y, Pb, Pr) video inputs

1. Connect one end of the RGB/Y,Pb,Pr cable to the Y/R, Pb/G, Pr/B jacks on the DVG-777K II's rear panel
2. Connect the other end of the RGB/Y,Pb,Pr cable to the RGB or Y, Pb, Pr inputs on a High Definition TV

NOTE: When using the Component output, the DVG-777K II must be set to YPBPR output. See "Changing the Video Output Mode" in the Operations section of this manual for detailed instructions on setting the DVG-777K II to YPBPR Mode.

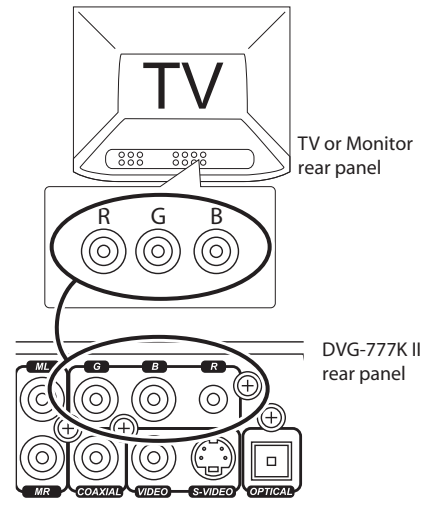

VGA output

What you will need:

- 1 VGA Cable
- A TV or video monitor with a VGA input

1. Connect one end of the VGA cable to the VGA output on the rear panel of the DVG-777K II
2. Connect the other end of the VGA cable to a VGA input jack on a TV or monitor

NOTE: When using the VGA output, the DVG-777K II must be set to VGA output. See "Changing the Video Output Mode" in the Operations section of this manual for detailed instructions on setting the DVG-777K II to VGA Mode.

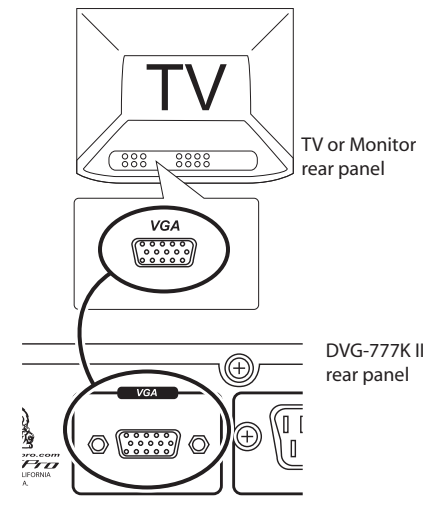

SCART

What you will need:

- 1 SCART cable
- A TV or video monitor with a SCART input

1. Connect one end of the SCART cable to the SCART output on the rear panel of the DVG-777K II
2. Connect the other end of the SCART cable to a SCART input jack on a TV or monitor

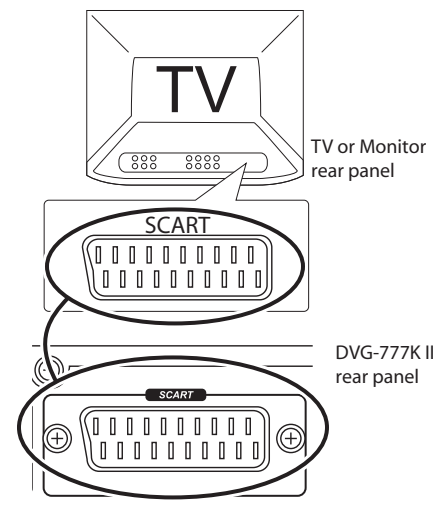

Getting Connected

Connecting a USB Device

The DVG-777K II allows you to connect a USB device and play A/V files using the remote control.

1. Connect the USB device to the USB port on the front panel
2. Use the USB button on the front panel or remote to access the USB device. The file menu will appear.
3. Use the remote control to navigate through the A/V files for playback

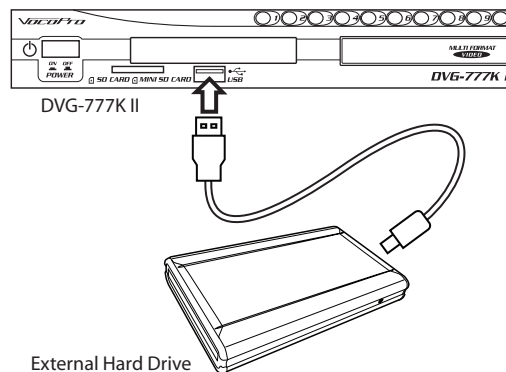

Connecting an SD CARD or MINI SD CARD

The DVG-777K II allows you to connect an SD CARD or MINI SD CARD to play A/V files using the remote control.

1. Insert the SD CARD or MINI SD CARD into the slot on the front panel. To view the files, press the SD CARD button on the remote or the USB button on the front panel to cycle through to the card.
2. Use the remote control to navigate through the A/V files for playback

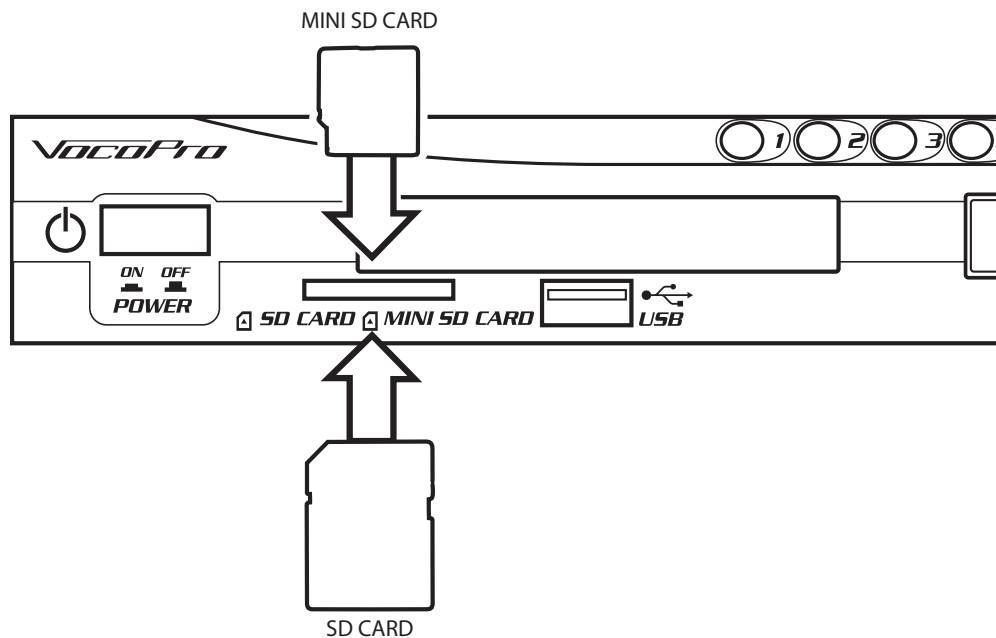

General Operations

General Operations

Turning on the Power

Main Power

The main power button for the DVG-777K II is located on the front panel.



1. Press the POWER button on the front panel to turn the DVG-777K II on and off

Standby

Once the main power is turned on, the DVG-777K II can be set to standby mode using the STANDBY button on the remote control.

1. Press the STANDBY button on the remote control while the player is on to set the player to standby mode
2. Press the STANDBY button again to turn the player back on

Inserting a Disc

1. Press the  button on the front panel or remote control to open the disc tray
2. Insert the disc label-side-up
3. Press the  button on the front panel or remote control a second time to close the disc tray

Playing a Disc

1. Insert a disc into the disc tray
2. Press the PLAY/PAUSE  button on the front panel or the  button on the remote control to begin playing

Stopping a Disc

1. Press the STOP button on the front panel or the  button on the remote control to stop a disc while it is playing



Pausing a Disc

1. While a disc is playing press the PLAY/PAUSE  button on the front panel or the  button on the remote control to pause the disc
2. Press the pause or play button again to resume playback

Muting a Disc

1. Press the MUTE button on the remote control to silence the disc
2. Press the MUTE button again to un-mute the disc

Skipping Tracks

1. Use the PREV/NEXT buttons on the front panel or the  to skip from one track to another
2. The NEXT  button skips forwards to the next track and the PREV  button skips back to the previous track

General Operations

Scanning through Tracks (CD, VCD, DVD, USB, and SD only)

1. Use the ►► ◀◀ buttons on the remote control to scan through tracks
2. The ►► button scans forwards through the current track and the ◀◀ backwards through the current track

Adjusting the Disc Music Volume

1. Use the VOL + and VOL - buttons on the remote control to adjust the volume
2. The VOL + button raises the volume and the VOL - button lowers it

Using Direct Track Access

The Direct Track Access buttons are the number buttons on the front panel and remote control. These allow you to jump directly to a track or chapter (DVD) by entering its number. When using Direct Track Access on the front panel, type the two digit equivalent of the number.

example

To jump directly to track 9:

1. Press the 0 and 9 buttons
2. Track 9 will begin playing

Jumping to a Specific Time on a track (CD, VCD and DVD only)

1. Press the SEARCH button on the remote control
2. Use the ARROW buttons to move to the 00:00:00
3. Enter the time on the track that you want to jump to
4. Press ENTER
5. The disc will play at that time

example

To jump directly to 1:45

1. Press SEARCH on the remote control
2. Press right ARROW button to get to the 00:00:00
2. Press 0, 1, 4, then 5
3. Press ENTER on the remote control
4. The disc will begin playing at 1:45 minutes in the disc

Programming a Custom Track Order

The DVG-777K II allows you to create a custom playlist of up to 16 tracks using the PROGRAM button on the remote control.

1. If there is a disc in the DVG-777K II, make sure it is stopped
2. Press the PROGRAM button on the remote control to access the Program menu. The Program menu will appear on the TV screen
3. Enter a track number using the number buttons on the remote control
4. Press ENTER on the remote control to enter that track into the playlist and to jump to the next playlist slot
5. Continue this until your playlist is complete

example (on next page)

General Operations

To create a playlist in the following order:

1. Track 14
2. Track 7
3. Track 3
4. Track 1

1. Press the PROGRAM button to enter Program mode
2. Press 14 and then ENTER
3. Press 7 and then ENTER
4. Press 3 and then ENTER
5. Press 1 and then ENTER
6. Press PLAY to begin playing in this order
7. Press STOP twice to exit the programmed playlist

Clearing a track in Program Mode

Press the CLEAR button on the remote control to erase the last programmed track.

Using Digital Key Control

Digital Key Control allows you to change the musical key of disc music to fit any singer's vocal range. The Digital Key Control buttons are located on the remote control and front panel

b - Lowers the musical key

4 (remote control only) - Resets the musical key back to the original or natural key

- Raises the musical key

Setting Repeat Options

Press the REPEAT button on the remote control to cycle through the available Repeat options

- REP-ONE: Repeats the same song continuously
- REP-ALL: Repeats the entire disc after it has played through
- REPEAT OFF: All Repeat options are off
- CHAPTER REPEAT (DVD only): Repeats the current chapter on a DVD disc
- TITLE REPEAT (DVD only): Repeats the current title on a DVD disc

Switching Between PAL and NTSC Video Modes

The DVG-777K II is defaulted to NTSC. Use the P/N button on the remote control to switch between PAL and NTSC.

1. If there is a disc in the DVG-777K II make, sure it is stopped
2. Press the P/N button on the remote control
3. Press ENTER on the remote control. The video mode will change

PAL: Europe and Asia

NTSC: North America

General Operations

Changing the Video Output Mode

The DVG-777K II has different video output channels: S-Video, SCART, VGA, Component, Etc. The DVG-777K II must be set to the correct video output mode when using these output channels.

To cycle through the different video output modes:

1. If there is a disc in the DVG-777K II, make sure it is stopped
2. Press the VIDEO button on the remote control
3. Press the ENTER button on the remote control to change to the next video mode
4. Follow steps 1 & 2 to cycle through all of the video output modes until you find the correct one for your setup

Looping a Section of Disc using the A-B Button (CD, VCD, DVD, USB and SD only)

1. Press the A-B button on the remote control to set the starting point of the loop
2. Press the A-B button again to set the ending point of the loop and to begin the loop
3. Press the A-B button a third time to cancel the loop and resume normal playback

Setting the KJ MODE function

The KJ MODE function will pause a disc at the one second mark. This is for use on CD+G karaoke discs with a song-title screen at the beginning of each song as it allows you to display the song-title for the audience before playing the song. Once the song is complete the DVG-777K II will stop playback at the completion of each track allowing you to prepare for the next performance.

1. Press the KJ MODE button on the remote control or front panel of the DVG-777K II to turn KJ MODE on. A message on the screen will indicate if KJ MODE has been turned on or off. Each song will pause at the one second mark
3. Press PLAY to begin playing each song

Using the Digital Equalizer (EQ)

The DVG-777K II has five preset equalizer settings plus one user-programmable one.

1. Press the EQ button on the remote control to open the EQ menu
2. Use the SRND tab to select one of the following Surround modes: Concert, Church, Passive, Wide, Live.
3. To change the EQ settings, select the EQ tab and choose one of the following mode: Standard, Classic, Jazz, Rock, Pop and User, in which you can customize the EQ settings.
4. View the live EQ with the BAND tab.
5. You can also enable the EQ mode with the MUSIC MODE button on the remote.

Customizing the EQ in User EQ mode

1. Follow the above instructions until USER is selected
2. Use the left and right arrow buttons on the remote control to select a band for adjusting
3. Use the up and down arrow buttons on the remote control to raise and lower the value on each band

Playing One Frame at a Time with the Step Function

The Step function allows you to view one frame at a time on DVDs and VCDs.

NOTE: The Step function does not work on CD+Gs

1. Press the STEP button to enter Step mode and pause the current frame
2. Press it again to jump to the next frame
3. Press PLAY to resume normal playback

General Operations

Playing Forwards and Reverse in Slow Motion

You can play a disc forwards or reverse at 1/2, 1/4 and 1/8 the normal speed

1. Press the SLOW button on the remote control to cycle through the Slow Motion options
2. Press the PLAY button to return to normal playback

Slow Motion options:

- SF 1/2X - Forwards at 1/2 the normal speed
- SF 1/4X - Forwards at 1/4 the normal speed
- SF 1/8X - Forwards at 1/8 the normal speed
- SF 1/2X - Reverse at 1/2 the normal speed
- SF 1/4X - Reverse at 1/4 the normal speed
- SF 1/8X - Reverse at 1/8 the normal speed

Turning on Random Mode

In Random Mode, the DVG-777K II will play the tracks on a disc in random order

1. If there is a disc in the DVG-777K II, make sure it is stopped
2. Press the RANDOM button on the remote control to turn Random Mode on and off.

NOTE: Random Mode does not work on DVD discs.

DVD Operations

Accessing the DVD Menu

Use the MENU button on the remote control to access the main menu on a DVD. Use the arrow buttons on the remote control to navigate through the main menu and the ENTER button to make selections.

Accessing the Title Screen

Each section on a DVD such as the movie, special features, etc. has its own title screen. Use the TITLE button on the remote control to access the title screen for the current section.

Turning on Subtitles

Use the SUBTITLE button on the remote control to cycle through the available subtitle languages on a DVD.

NOTE: The available subtitles vary from each DVD and some may not have any at all.

Changing the Angle View

Use the ANGLE button on the remote control to view multiple angles on a DVD with multiple angles available.

NOTE: Not all discs have multiple angles available.

Accessing Additional Dubbed Languages

Some DVDs have multiple languages dubbed over the original language for speakers of other languages. Use the AUDIO button on the remote control to cycle through these languages on DVDs with multiple languages available.

General Operations

Mp3, AVI and Media file Operations

When playing a disc, USB device, SD CARD or MINI SD CARD with Mp3 or AVI files in it, the file menu will be enabled. Use the arrow buttons to navigate through this menu and the ENTER or PLAY button on the remote control to make selections.

Navigating on the File Menu:

Select the file type you wish to view by selecting the MUSIC, PICTURE or VIDEO icon at the bottom of the menu and pressing ENTER. Navigate to the folder you would like to browse and press ENTER.

1 MUSIC ICON - Display and playback your MP3 audio files

-Use the ARROW buttons to select a track and press enter to begin playback.

-Press STOP to return to the menu.

2. PHOTO ICON - Display and review your JPG images.

-Use the right ARROW to select a file, or press play on any file to begin slideshow. Smaller thumbnail preview images will appear in the left pane.

-Use the PREV/NEXT **◀▶** buttons on the front panel or the remote to skip from one image to another.

-Use the ARROW buttons on the remote to rotate the image and the ZOOM button to zoom in and out.

-Press STOP to return to the menu.

3. VIDEO ICON - Display and playback your AVI, MPG, MP4.

-Press STOP to return to the menu.

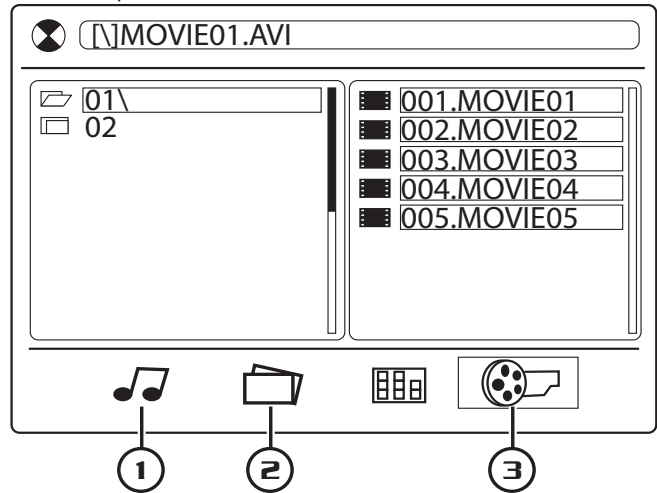

General Operations

Copying Music Files to SD or USB Memory

The DVG-777K II provides an easy and quick way to store your CD or CD+G music tracks as Mp3 files on an SD CARD or USB HARD-DRIVE by copying or "ripping" tracks.

Begin play of the CD and press the COPY button on the remote to enter the CD Copy Menu.

OPTIONS:

ENCODER OPTIONS

SPEED: Select 1x or 4x as the copy speed. Choose 1X if you would like to listen to the track as you copy, 4x for faster ripping.

BITRATE: Choose the bitrate of your track. You can choose 128KBPS, 160KBPS, 192 KBPS, 256KBPS or 320KBPS. A higher bitrate improves sound quality but uses up more disk space on the memory device. 192KBPS is considered to be comparable to CD quality and manageable in file size.

FILE OPTIONS

CREATE ID3 TAG: Create an ID3 tag for your MP3 tracks.

CREATE PLAYLIST: Create a playlist for your MP3 tracks.

STORAGE

Select USB to store the MP3 files on your connected drive or CARD to store to SD Card.

RIP CD-		UNKNOWN ALBUM	
▶ OPTIONS TRACKS START QUIT	ENCODER OPTIONS		
	SPEED	1X	
	BITRATE	128KBPS	
	FILE OPTIONS		
	CREATE ID3 TAG	<input checked="" type="checkbox"/>	
	CREATE PLAYLIST	<input checked="" type="checkbox"/>	
	STORAGE OPTIONS		
	STORAGE	USB	

TRACKS:

This sub-menu displays each track and length. By default all tracks are selected for ripping, you can select/deselect all tracks by selecting and pressing ENTER on the box at the top of the list, or select/deselect individual tracks by selecting the box next to the track and pressing ENTER.

RIP CD-		UNKNOWN ALBUM		
▶ OPTIONS TRACKS START QUIT	<input checked="" type="checkbox"/>	TRK	TITLE	LENGTH
	<input checked="" type="checkbox"/>	1.	TRACK 1	3:43
	<input checked="" type="checkbox"/>	2.	TRACK 2	3:33
	<input checked="" type="checkbox"/>	3.	TRACK 3	2:54
	<input checked="" type="checkbox"/>	4.	TRACK 4	2:31
	<input checked="" type="checkbox"/>	5.	TRACK 5	3:53
	<input checked="" type="checkbox"/>	6.	TRACK 6	2:47
	<input checked="" type="checkbox"/>	7.	TRACK 7	3:01
	<input checked="" type="checkbox"/>	8.	TRACK 8	3:06
	<input checked="" type="checkbox"/>	9.	TRACK 9	3:44
<input checked="" type="checkbox"/>	10.	TRACK 10	3:33	

START

Select this option and press ENTER to begin ripping your tracks. You can adjust recording speed during ripping, but selecting 4X will not allow you to listen as the copying occurs.

RIP CD-		UNKNOWN ALBUM	
▶ OPTIONS TRACKS START QUIT	SUMMARY		
	TOTAL TRACKS	33	
	TOTAL TIME	51:13	
	TOTAL SIZE	46.8MB	
PRESS ENTER TO BEGIN			

QUIT

Select this option to exit the menu.

Front Panel

Front Panel

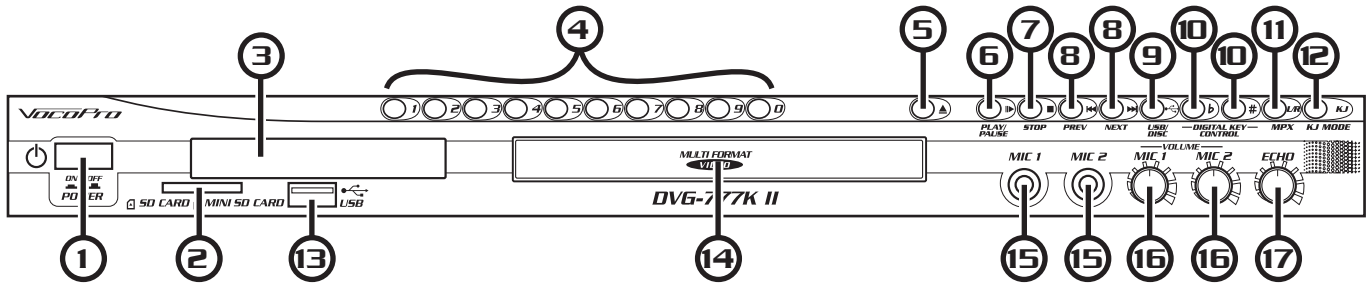

- 1. Main POWER button** - Turns the power on and off.
- 2. SD CARD/MiniSD CARD slot** - Insert an SD CARD or MiniSD CARD here for A/V file playback.
- 3. Display screen** - Displays the player's operating status.
- 4. Direct Track Access (number) buttons** - For use whenever number input is necessary. i.e. Jumping directly to tracks/chapters, programming tracks in program mode, parental password, etc. See the Operations section in this manual for detailed instructions.
- 5. EJECT ▲ button** - Opens and closes the disc tray
- 6. PLAY/PAUSE ||▶ button** - Plays a disc that is stopped or paused and pauses a disc that is playing.
- 7. Stop ■ button** - Stops a disc that is playing.
- 8. PREV and NEXT ◀▶ buttons** - Press PREV to jump to the previous track and NEXT to jump to the next track.
- 9. USB/CARD/DISC ↻ button** - Toggles between disc player, SD Card and USB input.
- 10. Digital Key Control** - Adjusts the musical key to fit a singer's vocal range. Press "b" to lower the key and "#" to raise the key.
- 11. L/R button** - Turns multiplexing on and off, allowing you to remove vocals from a multiplex-enabled CD+G.
- 12. KJ MODE** - This function will pause a disc at the 1 second mark. This is for use on CD+G karaoke discs with a song-title at the beginning of each song as it allows you to display the song-title for the audience before playing the song.
- 13. USB input** - Connect a USB device here for A/V file playback.
- 14. Disc Tray** - Insert discs here.
- 15. MIC 1 & 2 Input jacks** - Connect microphones here using 1/4" microphone cables.
- 16. MIC 1 & 2 Volume controls** - For adjusting each microphone's individual volume. Turn clockwise to raise the microphone volume and counter-clockwise to lower it.
- 17. ECHO level control** - For adjusting the amount of Echo that is present in the microphone vocals. Turn clockwise to raise the Echo level and counter-clockwise to lower it.

Rear Panel

Rear Panel

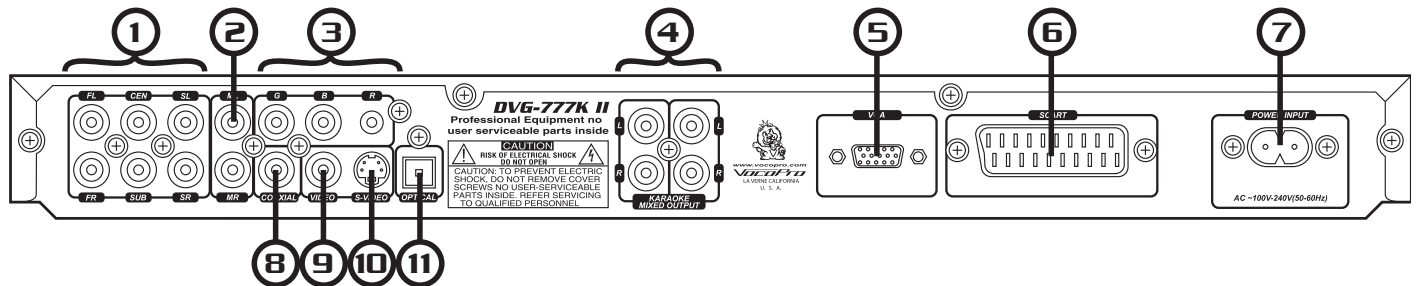

1. **5.1 Surround Sound Output jacks** - For connecting to a 5.1 CH. surround sound system. FL -Front Left, FR - Front Right, SW - Subwoofer, SL -Side Left, SR - Side Right, CEN -Center.

2. **ML and MR Output jacks (music only)** - Connect to a mixer or sound system to output music.

3. **RGB(Y/Pb/Pr)/Component Video output** - Connect video to a TV with RGB(Y/Pb/Pr) or Component video inputs using RGB(Y/Pb/Pr) cables.

4. **Karaoke Mixed Output jacks (mic and music)** - Connect to a mixer, amp, or TV audio inputs using two RCA cables to output the music and microphone signal together.

5. **VGA output (video)** - For Video output using a VGA video cable.

6. **SCART** - For Video output using a SCART video cable.

7. **Power Input** - Connect the power cord (included) here.

NOTE: Make sure the power cord is firmly connected to the Power Input before turning the player on.

8. **Digital Coaxial Output (music only)** - Connect to a sound system with digital Coaxial audio input using a digital audio cable.

NOTE: Although it is alright to use standard RCA cables, it is recommended that you use Digital RCA audio cables for optimum digital signal.

9. **Video Output (RCA)** - Connect to a TV/Video monitor using an RCA video cable.

10. **S-Video Output** - Connect to a TV/video monitor with an S-Video input jack using an S-Video video cable.

11. **Digital Optical Audio Output** - Connect to a sound system with an Optical audio input using a digital audio cable.

Remote Control

1. **STANDBY button** - Turns Standby mode on and off.
2. **▲ button** - Opens and closes the disc tray.
3. **SD CARD** - Enables SD CARD MODE to access files on your SD or MINI SD Card.
4. **USB button** - Enables USB DEVICE MODE to access files on your USB device .
5. **DISC button** - Enables DISC MODE to playback your DVD, CD or CD+G disc.
6. **MUSIC MODE button** - Use this button to choose between six different EQ modes. Customize USER mode with the EQ button on the remote control.
7. **Direct Track Access (number) buttons** - For use whenever number input is necessary. i.e. Jumping directly to tracks/chapters, programming tracks in program mode, parental password, etc. See the Operations section in this manual for detailed instructions.
8. **P/N button** - Switches between PAL and NTSC video modes. To change video modes press the P/N button until desired mode is selected.
9. **VIDEO button** - Cycles through the available video output modes: VGA, S-Video, RGB and SCART. To change the video output mode press the VIDEO button until desired mode is selected.
10. **SEARCH button** - Opens up the GO TO menu which allows you to jump to a certain time on DVDs, VCDs and CDs. See the Operations section in this manual for detailed instructions on using the Search option.
11. **CLEAR button** - Erases numbers entered into a menu without closing the menu
12. **PROGRAM button** - Opens the Program Menu which lets you program a custom playlist order of up to 16 tracks. See the Operations section in this manual for detailed instructions on using the Program Menu.

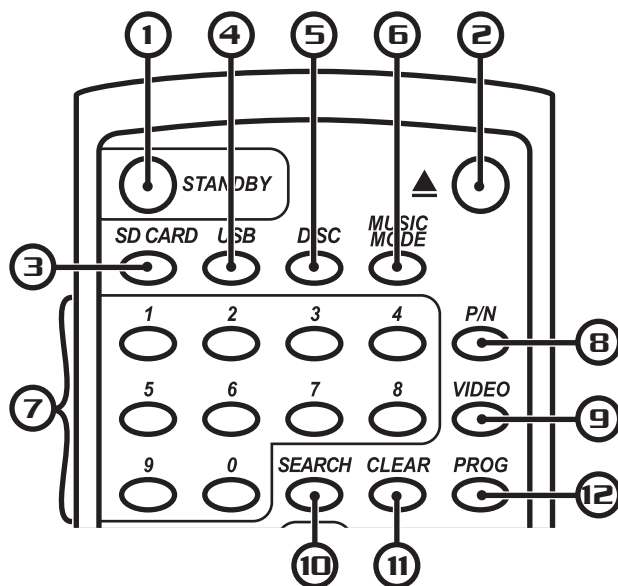

13. **TITLE button** - Accesses the title screen on a DVD.
- NOTE:** For use on DVDs with title screens. Some DVDs may not have a title screen.
14. **MENU button** - Accesses the main menu on DVDs and other discs with main menus.
15. **SETUP button** - Accesses the Setup Menu. See the Setting Up Preferences section in this manual for detailed instructions on using the Setup Menu.
16. **REPEAT button** - Cycles through the available repeat options. Repeat options vary depending on the type of disc. See the Operations section in this manual for detailed instructions on using the Repeat function.
17. **SUBTITLE button** - Turns on subtitles for DVDs with subtitles available.

NOTE: Not all DVDs have subtitles available.

18. **ARROW buttons** - For navigating through on-screen menus.
19. **ENTER button** - For making selections in on-screen menus.
20. **A-B button** - For setting a section on a disc for continuous looping. See the Operations section in this manual for detailed instructions on using the A-B loop feature.
21. **PBC button** - Turns on Playback Control (PBC). For use with VCD 2.0 discs, PBC allows you to navigate more conveniently through VCD 2.0 discs.
22. **ANGLE button** - For viewing multiple angles on a DVD with multiple angles available.
- NOTE:** Not all DVDs have multiple angles available.
23. **ZOOM button** - For zooming in on the picture on DVDs, CD+Gs and VCDs.
24. **VIEW button** - For viewing specific sections on a VCD disc. The VIEW button can also be used to preview the first 10 seconds of each track.

NOTE: The disc must be stopped in order to access the VCD View Menu.

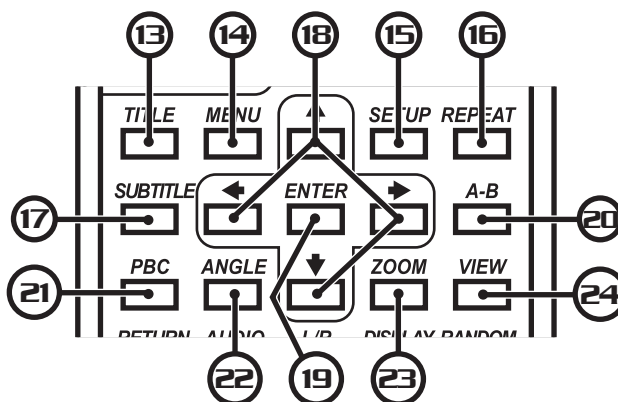

Remote Control

25. RETURN button - Accesses the main menu on a VCD 2.0 disc.

NOTE: PBC must be turned on and the VCD must be a VCD 2.0 disc.

26. AUDIO button - Cycles between the available audio languages on DVDs with multiple languages available.

NOTE: Not all DVDs have multiple languages available.

27. L/R button - Cycles through the different multiplex CD+G output modes for canceling the vocals: MONO-LEFT, MONO-RIGHT, STEREO. See the Operations section in this manual for detailed instructions on canceling vocals on multiplex CD+G discs.

28. DISPLAY button - Cycles through available disc time info and displays it on the TV/video monitor.

29. RANDOM button - Turns Random Mode on and off. In Random Mode, the player randomly picks tracks from a disc for playback.

30. RESUME button - Closes the Setup Menu.

31. EQ button - Access the SURROUND and EQ menu.

32. SLOW button - Cycles through available Slow-motion Reverse and Slow-motion Forward options. See the Operations section in this manual for using the slow-motion function.

33. STEP button - For viewing one frame at a time on video discs. See the Operations section in this manual for detailed instructions on using the Step function.

34. MUTE button - Mutes all disc music and movie audio.

35. COPY MODE* button - This will enable the COPY MODE for ripping cd tracks to an SD Card or USB Device. Confirm that you have either an SD Card or USB Device plugged in to enable this mode. Also, the CD you would like to copy from must be in playback mode.

36. KJ MODE - This function will pause a disc at the one second mark. This is for use on CD+G karaoke discs with a song-title at the beginning of each song as it allows you to display the song-title for the audience before playing the song. This function also stops playback between tracks to allow preparations for a performance.

37. Digital Key Control - Adjusts the musical key to fit a singer's vocal range. Press "b" to lower the key and "#" to raise the key and \natural to return back to the original (natural) key.

38. ▶ button - Plays a disc.

39. || button - Pause the disc.

40. ▶▶ ◀◀ - For scanning through a track. ◀◀ scans backwards and ▶▶ scans forwards.

41. ■ button - Stops the disc.

42. ▶▶ ◀◀ buttons - Press ◀◀ to jump to the previous track and ▶▶ to jump to the next track.

43. VOL + & VOL - buttons - Adjusts the master music volume.

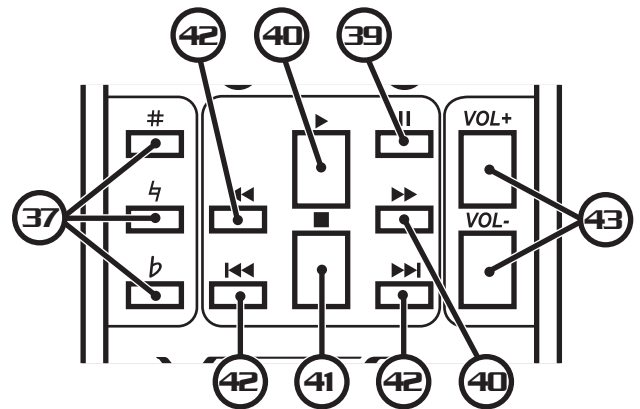
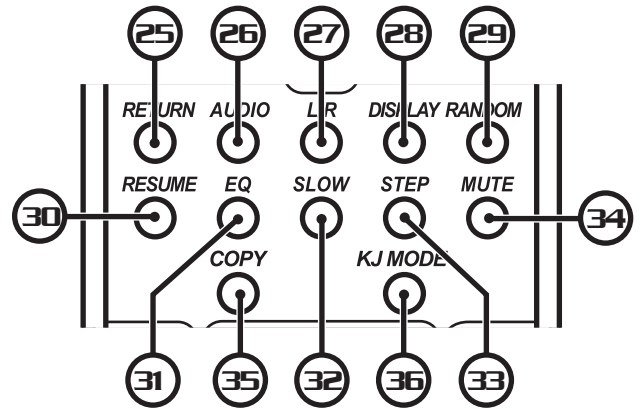

Setup Menu

The Setup Menu can be accessed by pressing the SETUP button on the remote control and allows you to change the DVG-777K II's system settings. Use the arrow keys to select each page tab at the top of the screen.

System Setup Page

1. TV SYSTEM

Select PAL or NTSC to match the region setting of your tv type. Select AUTO to have the DVG-777K II detect the format.

2. SCREEN SAVER

Screen saver is used to protect your TV/video monitor when the player is idle for a significant period of time.

ON: A screen saver will appear after the DVG-777K II is idle for a period of time.

OFF: There will be no screen saver.

3. HD OUTPUT

Select the output of the COMPONENT VIDEO connections. Select 720p or 1080i based on your TV's specifications.

4. VIDEO

Select your video output based on your output connections.

5. TV TYPE

Select one of these choices to match your television or viewing preferences:

4:3PS - 4:3 "Pan & Scan" is for viewing video on a standard TV

4:3LB - 4:3 Letterbox is for widescreen presentations on a standard TV.

16:9 - This setting is for widescreen TV.



To view the standard 4:3 picture or the cut standard 4:3 picture

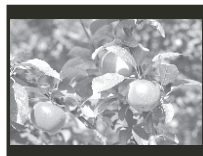

4:3 subtitle block to view the full width of the widescreen mode



16:9 To view widescreen picture with a widescreen TV set

Standard TV set

Widescreen TV set

NORMAL/PS

NORMAL/LB

WIDE

6. PASSWORD

Create a new password. The first time you change the password you will need to enter the original factory password which is 0000.

You can also enter 0000 if you forget your new password in order to create a new one.

7. RATING

Set the parental rating for DVDs.

8. NEXT PAGE

Move to the next page of options.

9. DEFAULT

Restore the default settings.

Setup Menu

10. RESUME

With RESUME set to ON the player will start playback from the last track played. If this setting is turned off, playback will begin at the first track.

11. PREV PAGE

LANGUAGE SETUP

1. OSD LANGUAGE

Change the on screen display language. The default is English.

2. AUDIO LANGUAGE

Change the audio language of your DVD discs with this option.

3. SUBTITLE LANGUAGE

Change the subtitle language. The default is English.

4. MENU LANGUAGE

Change the menu language. The default is English.

Audio Setup Page

1. AUDIO OUT

Turn on SPDIF and select SPDIF type if you are utilizing digital audio.

2. KEY

Adjusts the musical key to fit a singer's vocal range. Move the arrow toward "b" to lower the key and "#" to raise the key.

Video Setup Page

Adjust the picture output to your preference with these four video settings.

1. BRIGHTNESS

2. CONTRAST

3. HUE

4. SATURATION

Speaker Setup Page

1. DOWNMIX

LT/RT: Sound output is divided with the Left coming out of the Left speaker and the Right coming out of the Right speaker.

STEREO: Sound output is in Stereo Mode.

VSS:

5.1

2. SUBWOOFER

ON: There will be output from the SUB speaker output jack

OFF: The SUB output is off.

3. CENTER DELAY

Use this to synchronize the center (CEN) speaker with the rest of the speakers in your Surround Sound speaker system.

4. REAR DELAY

Use this to synchronize the SL and SR speakers with the rest of the speakers in your Surround Sound speaker system.

Setup Menu

5. FRONT

LARGE: If you have front speakers capable of low frequency output.

SMALL: If you have front speakers that are not capable of low frequency output.

DIGITAL SETUP

OP MODE

Select Line Out or RF Remodulation.

DYNAMIC RANGE

Setting the compression allows you to play music at a lower volume without losing the original quality of the sound. Great for late night use.

OFF: No Compression

2/8: High compression for quieter (late night) use

4/8: Medium compression for general use

6/8: Low compression

FULL: Full-volume cinematic sound

DUAL MONO

STEREO OUTPUT: Outputs audio in stereo.

L-MONO: Plays the Left side only through both Left and Right speaker outputs on a Multiplex disc.

R-MONO: Plays the Right side only through both the Left and Right speaker outputs on a Multiplex disc.

MIX-MONO: Plays virtual stereo with Left and Right Mono coming out of the Left and Right speaker outputs.

Troubleshooting

There is no power

- Make sure the power cord is firmly connected to the back of the DVG-777K II and to the power outlet
- If using a power strip/surge-protector, make sure that it is plugged in and switched on

There is no sound

- Make sure everything is connected firmly and properly
- Make sure there are no defective cables
- Make sure all of your components are turned on
- Make sure all of the components (amp, mixer, TV, etc.) are set to the proper inputs

No picture

- Make sure everything is connected firmly and properly
- Make sure there are no defective cables
- Make sure all of your components are turned on
- Make sure all of the components (amp, mixer, TV, etc.) are set to the proper inputs
- Make sure the TV or monitor is working correctly
- Make sure the DVG-777K II is set to the correct video output mode using the VIDEO button on the remote control

The disc does not play

- Make sure the disc is inserted correctly (label-side up)
- Make sure the disc is clean and not scratched
- If using a CD/DVD R/RW, try using a different brand as some brands might not be compatible
- Clean the CD lens using a CD lens cleaner

Remote control does not work

- Make sure the batteries are inserted, inserted correctly, and not out of power.
- Point the remote control directly at the remote sensor on the machine
- Move closer to the machine

The picture is unclear

- Make sure the disc is not dirty or damaged
- Make sure that the TV TYPE (P/N button on the remote) is set correctly:
 - NTSC: In North America
 - PAL: In Europe and Asia
- Try restarting the DVG-777K II

NOCARD error when attempting to playback off of an SD Card

- Make sure that the SD Card is inserted completely.
- Turn off the DVG-777K II, remove the SD Card, reconnect and turn the DVG-777K II back on.

NOUSB error when attempting to playback off of a USB Drive

- Turn off the DVG-777K II, remove the USB Drive, reconnect and turn the DVG-777K II back on.

VocoPro[®]

THE SINGER'S ULTIMATE CHOICE[™]

