

VocoPro

ULTIMATE CHOICE OF KARAOKE ENTERTAINMENT

FEATURES:

- Four Dual-Channel Frequency Presets for a Total of 8 Selectable Channels for Trouble-free UHF Operation
- Interference-resistant UHF Band Operation from 520 - 570 MHz
- Detachable Front-Panel and Mic-Transmitter RF Antennas
- Independent Front-Panel Volume Control and Channel Selection
- Included Mounting Brackets for Easy Rack Mounting
- Rugged 1RU Metal Receiver Housing
- XLR Balanced and 1 / 4" Unbalanced Outputs with Separate/Mixed Output Options
- 110V-240V Switchable

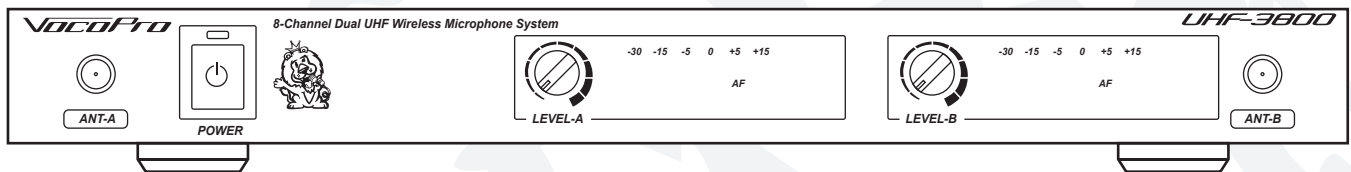

UHF-3800

8 Channel UHF Dual Wireless Microphone System

Safety Instructions



CAUTION
RISK OF SHOCK



CAUTION: To reduce the risk of electric shock, do not remove cover (or back). No user-serviceable parts inside. Only refer servicing to qualified service personnel.

Explanation of Graphical Symbols



The lightning flash & arrowhead symbol, within an equilateral triangle, is intended to alert you to the presence of danger.



The exclamation point within an equilateral triangle is intended to alert you to the presence of important operating and servicing instructions.

WARNING

To reduce the risk of fire or electric shock, do not expose this unit to rain or moisture.

- 1. Read Instructions** - All the safety and operating instructions should be read before the appliance is operated.
- 2. Retain Instructions** - The safety and operating instructions should be retained for future reference.
- 3. Heed Warnings** - All warnings on the appliance and in the operating instructions should be adhered to.
- 4. Follow Instructions** - All operating and use instructions should be followed.
- 5. Attachments** - Do not use attachments not recommended by the product manufacturer as they may cause hazards.
- 6. Water and Moisture** - Do not use this unit near water. For example, near a bathtub or in a wet basement and the like.
- 7. Carts and Stands** - The appliance should be used only with a cart or stand that is recommended by the manufacturer.
 - 7 A.** An appliance and cart combination should be moved with care. Quick stops, excessive force, and uneven surfaces may cause an overturn.



8. Ventilation - The appliance should be situated so its location does not interfere with its proper ventilation. For example, the appliance should not be situated on a bed, sofa, rug, or similar surface that may block the ventilation slots.

9. Heat - The appliance should be situated away from heat sources such as radiators, heat registers, stoves, or other appliances (including amplifiers) that produce heat.

10. Power Sources - The appliance should be connected to a power supply only of the type described in the operating instructions or as marked on the appliance.

11. Grounding or Polarization - Precautions should be taken so that the grounding or polarization means of an appliance is not defeated.

12. Power-Cord Protection - Power-supply cords should be routed so that they are not likely to be walked on or pinched by items placed upon or against them, paying particular attention to cords at plugs, convenience receptacles, and the point where they exit from the appliance.

13. Cleaning - Unplug this unit from the wall outlet before cleaning. Do not use liquid cleaners or aerosol cleaners. Use a damp cloth for cleaning.

14. Power lines - An outdoor antenna should be located away from power lines.

15. Nonuse Periods - The power cord of the appliance should be unplugged from the outlet when left unused for a long period of time.

16. Object and Liquid Entry - Care should be taken so that objects do not fall and liquids are not spilled into the enclosure through openings.

17. Damage Requiring Service - The appliance should be serviced by qualified service personnel when:

- A. The power supply cord or plug has been damaged; or
- B. Objects have fallen into the appliance; or
- C. The appliance has been exposed to rain; or
- D. The appliance does not appear to operate normally or exhibits a marked change in performance; or
- E. The appliance has been dropped, or the enclosure damaged.

18. Servicing - The user should not attempt to service the appliance beyond that described in the operating instructions. All other servicing should be referred to qualified service personnel.

Note:

To CATV system installer's (U.S.A.): This reminder is provided to call the CATV system installer's attention to Article 820-40 of the NEC that provides guidelines for proper grounding and, in particular, specifies that the cable ground shall be connected as close to the point of cable entry as practical.



Welcome!

Thank you for purchasing the **UHF-3800** from VocoPro, your ultimate choice in Karaoke entertainment! With years of experience in the music entertainment business, VocoPro is a leading manufacturer of Karaoke equipment, and has been providing patrons of bars, churches, schools, clubs and individual consumers the opportunity to sound like a star with full-scale club models, in-home systems and mobile units. All our products offer solid performance and sound reliability, and to further strengthen our commitment to customer satisfaction, we have customer service and technical support professionals ready to assist you with your needs. We have provided some contact information for you below.

VocoPro

1728 Curtiss Court
La Verne, CA 91750

Toll Free: 800-678-5348

TEL: 909-593-8893

FAX: 909-593-8890

VocoPro Company Email Directory

Customer Service & General Information

info@vocopro.com

Tech Support

techsupport@vocopro.com

Remember Our Website

Be sure to visit the VocoPro website www.vocopro.com for the latest information on new products, packages and promo's. And while you're there don't forget to check out our Club VocoPro for Karaoke news and events, chat rooms, club directories and even a Service directory!

We look forward to hearing you sound like a PRO, with VocoPro, your ultimate choice in Karaoke entertainment.

FOR YOUR RECORDS

Please record the model number and serial number below, for easy reference, in case of loss or theft. These numbers are located on the rear panel of the unit. Space is also provided for other relevant information

Model Number _____

Serial Number _____

Date of Purchase _____

Place of Purchase _____

UHF-3800

8-Channel UHF Wireless Microphone System

Contents

Safety Instructions.....	1
Welcome.....	2
Features.....	3
Listening for a Lifetime.....	4
Microphone Basics.....	5
UHF-3800 & Stage Monitor/P.A. Loudspeakers.....	6
Before Getting Started.....	7
Front and Rear Panel Descriptions.....	8
Microphone Description and Functions.....	9
Mounting.....	10
Getting Connected.....	11
Operations.....	12
Tips for Achieving Optimum Performance.....	13,14
Troubleshooting.....	15
Specifications.....	16

FEATURES:

- Four Dual-Channel Frequency Presets for a Total of 8 Selectable Channels for Trouble-free VHF Operation
- Interference-resistant UHF Band Operation from 520 - 570 MHz
- Detachable Front-Panel and Mic-Transmitter RF Antennas
- Independent Front-Panel Volume Control and Channel Selection
- Included Mounting Brackets for Easy Rack Mounting
- Rugged 1RU Metal Receiver Housing
- XLR Balanced and 1 / 4" Unbalanced Outputs with Separate/Mixed Output Options
- 110V-240V Switchable



Listening for a Lifetime

Selecting fine audio equipment such as the unit you've just purchased is only the start of your musical enjoyment. Now it's time to consider how you can maximize the fun and excitement your equipment offers. VocoPro and the Electronic Industries Association's Consumer Electronics Group want you to get the most out of your equipment by playing it at a safe level. One that lets the sound come through loud and clear without annoying blaring or distortion and, most importantly, without affecting your sensitive hearing.

Sound can be deceiving. Over time your hearing "comfort level" adapts to a higher volume of sound. So what sounds "normal" can actually be loud and harmful to your hearing. Guard against this by setting your equipment at a safe level BEFORE your hearing adapts.

To establish a safe level:

- Start your volume control at a low setting.
- Slowly increase the sound until you can hear it comfortably and clearly, and without distortion.

Once you have established a comfortable sound level:

- Set the dial and leave it there.
- Pay attention to the different levels in various recordings.

Taking a minute to do this now will help to prevent hearing damage or loss in the future. After all, we want you listening for a lifetime.

Used wisely, your new sound equipment will provide a lifetime of fun and enjoyment. Since hearing damage from loud noise is often undetectable until it is too late, this manufacturer and the Electronic Industries Association's Consumer Electronics

Some common decibel ranges:

Level	Example
30	Quiet library, Soft whispers
40	Living room, Refrigerator, Bedroom away from traffic
50	Light traffic, Normal Conversation
60	Air Conditioner at 20 ft., Sewing machine
70	Vacuum cleaner, Hair dryer, Noisy Restaurant
80	Average city traffic, Garbage disposals, Alarm clock at 2 ft.

The following noises can be dangerous under constant exposure:

Level	Example
90	Subway, Motorcycle, Truck traffic, Lawn Mower
100	Garbage truck, Chainsaw, Pneumatics drill
120	Rock band concert in front of speakers
140	Gunshot blast, Jet plane
180	Rocket launching pad

Microphone Basics

Microphone Position

The UHF-3800 is ideal for close-up vocals and can be held in the hand or mounted on a mic stand. The most common applications and placement techniques are listed below. Keep in mind that microphone technique is largely a matter of personal taste, there is no one "correct" microphone position.

Proximity Effect

When the sound source is less than 1/4 in. from the microphone, the microphone boosts bass frequencies (by 6 to 10 dB at 100 Hz), creating a warmer and richer bass sound than when farther away. This effect, known as proximity effect, happens only in unidirectional dynamic microphones like the UHF-3800.

Feedback

Feedback occurs when the amplified sound from any loudspeaker reenters the sound system through any open microphone and is amplified again and again and again. Most commonly, feedback is caused by the following conditions: placing loudspeakers too close to microphones, having too many open active microphones, boosting tone controls indiscriminately (mainly treble) and performing in areas with high ratios of room surfaces that have hard and reflective surfaces such as glass, marble and wood. What to do if feedback occurs before the sound system is loud enough?

- Request that the talker speak louder into the microphone.
- Reduce the distance from the talker to the microphone. Each time this distance is halved, the sound system output will increase by 6dB.
- Reduce the number of open microphones.
- Move the loudspeaker farther away from the microphone. Each time this distance is doubled, the sound system output can be increased by 6dB.
- Move the loudspeaker closer to the listener.
- Use an equalizer/feedback reducer to cut the frequency bands in which the feedback occurs.

Microphone Placement & Tone Quality

Lead & Backup Vocals

Lips should be less than 3" from or even touching the windscreen on an axis to the microphone. Doing this creates a robust sound, emphasizes bass and provides maximum isolation from other sources.

Speech

When giving a speech or simply speaking, place the microphone 4" to 10" away from the mouth, just above nose height for a natural sound with reduced bass. You can also place the microphone 8" to 16" away from the mouth, slightly off to one side, for a more "distant" sound with highly reduced bass and minimal "s" sounds.

UHF-3800 & Stage Monitor/P.A. Loudspeakers

If you will be using the UHF-3800 with stage monitors and/or P.A. system, try the following:

- Place the stage monitor directly behind the microphone.
- Locate the P.A. loudspeakers so that they point away from the rear of the microphone. (With the speakers located in these positions, the possibility of feedback is greatly reduced).
- Always check the stage setup before a performance to ensure optimum placement of microphone and monitors.

IMPORTANT: Every wireless microphone installation is a unique situation, and can present a variety of problems. Never attempt a live performance without first conducting a "walkthrough" test of the system in the performing area. If major changes (additional wireless systems or intercoms, relocation of scenery, etc.) have been made since the last walk-through test, check the wireless system again, as close to performance time as possible.

Stage Setup (Overhead)

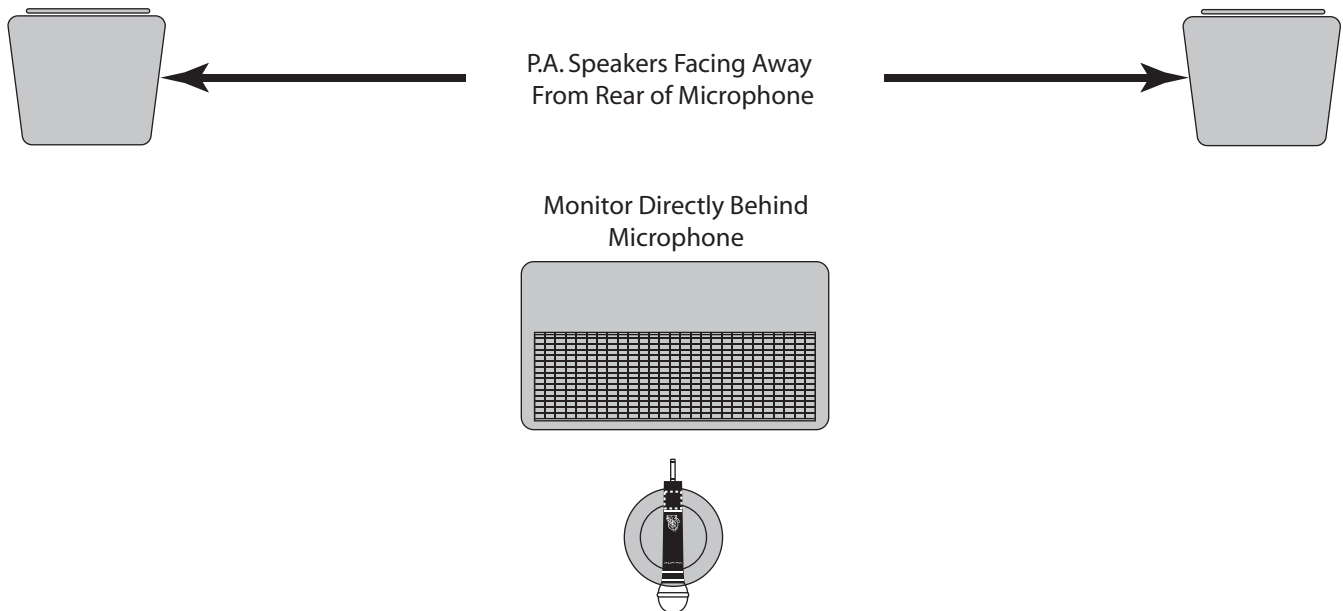

Before Getting Started

Before starting any installation procedures, it is recommended to completely unpack all the package contents. The original packaging should be kept in the event that re-shipping is needed. Upon unpacking the UHF-3800, you should have received the following items:

- Custom Aluminum Travel Case (1)
- UHF-3800 Receiver (1)
- Handheld Microphones (2)
- AA Batteries (6)
- RF Front Panel Antennas (2)
- Mic Transmitter Antennas (2)
- AC Power Adapter (1)
- 1/4" Microphone Cables (2)
- Mounting Brackets (2)
- Bracket Screws (6)

UHF-3800 Package Contents

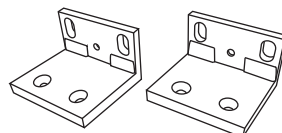
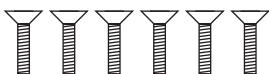
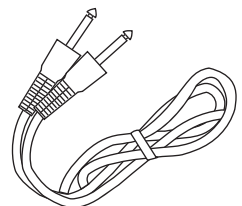
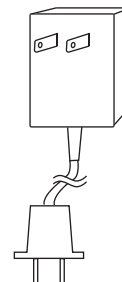
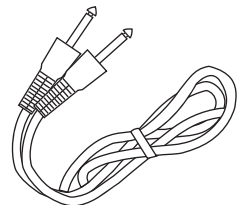
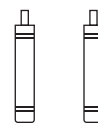
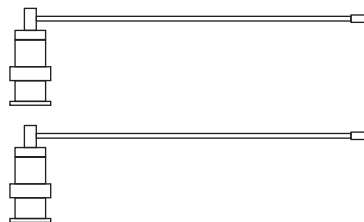
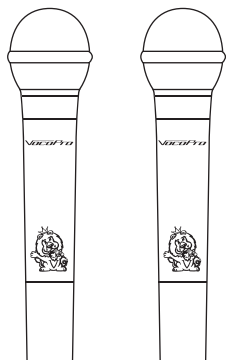
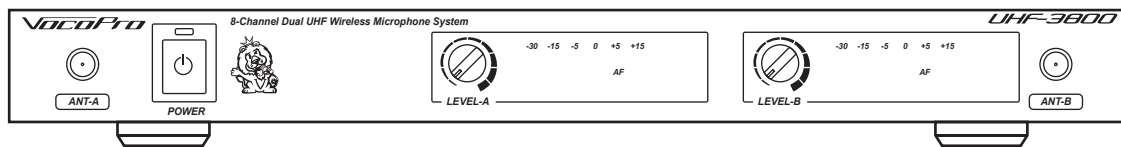
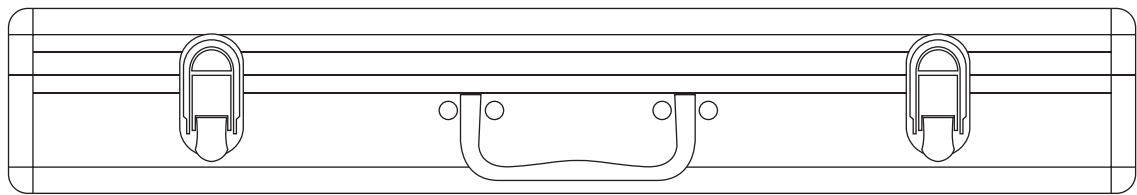

Front and Rear Panel Descriptions

- 1. POWER button** - Turns the UHF-3800 ON/OFF.
- POWER LED indicator** - Glows BLUE when the receiver is powered ON.
- RF/AF LED indicator** - Lights RED when RF signals are received from the microphone channels and output to external devices.
- VOLUME controls** - These controls adjust the VOLUME level for each MIC channel.
- RF ANTENNAS** - Provides RF SIGNAL reception to the RECEIVER.
- 1/4" AUDIO OUT (MIXED A-B)** - This 1/4" unbalanced OUTPUT jack is for output connection to amplifiers, effects devices or mixers. Both Mic channels are output through this jack for mixed output.
- XLR AUDIO OUT (SEPARATE A-B)** - These XLR balanced OUTPUT jacks are for output connections to amplifiers, effects devices and/or mixers. These are for separate mic channel connections with unmixed mic output.
- CHANNEL SELECTOR** - This selects one of the four dual-channel frequency pre-sets. The receiver and mics must all be set to the same pre-set. For example, if this is set to "1", both mics must also have their channels set to "1" to work.
- FUSE terminal** - This terminal houses the system fuse. Only replace with same type/rating of fuse.
- VOLTAGE selector** - Selects between 110-120V and 220-240V power settings.
- AC POWER terminal** - MAINS POWER jack for connection to a compatible AC outlet.

Front and Rear Panel

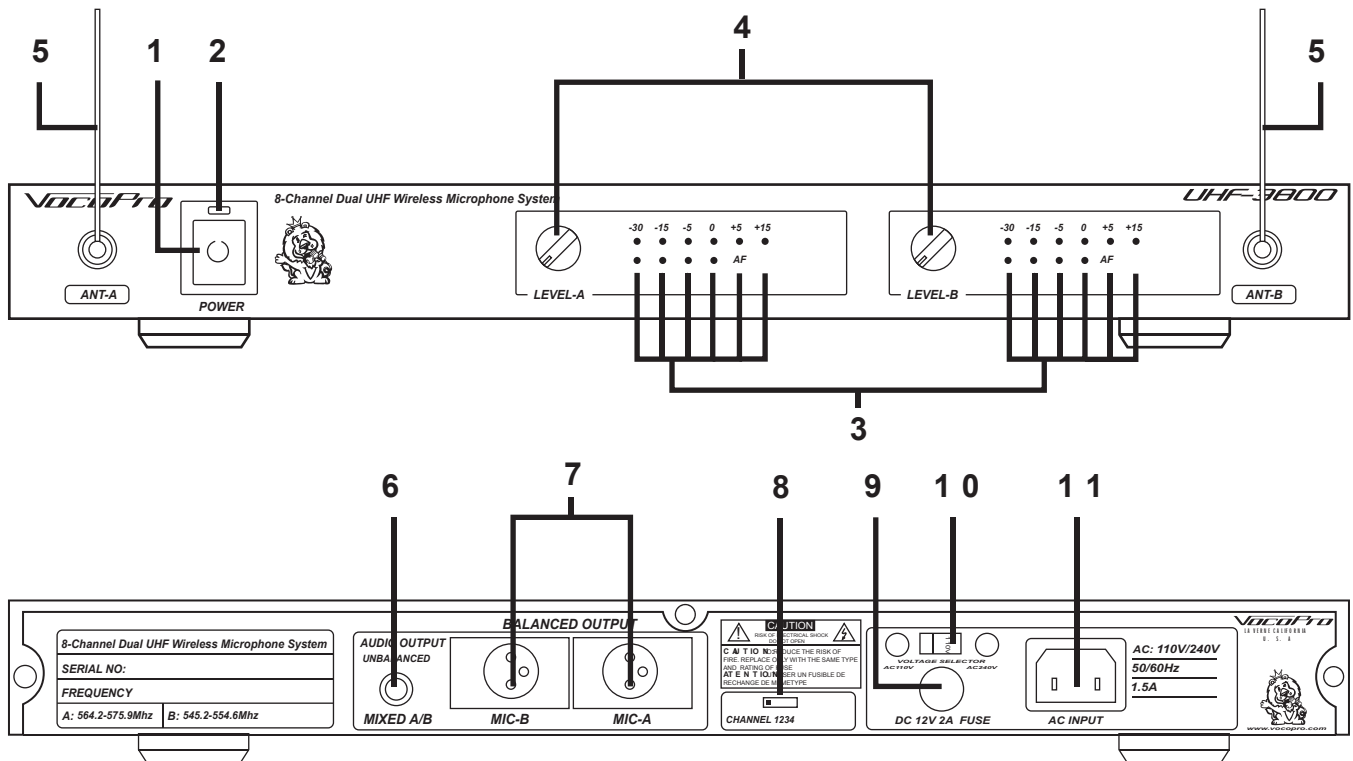

Microphone Descriptions and Functions

UHF-3800 Microphone

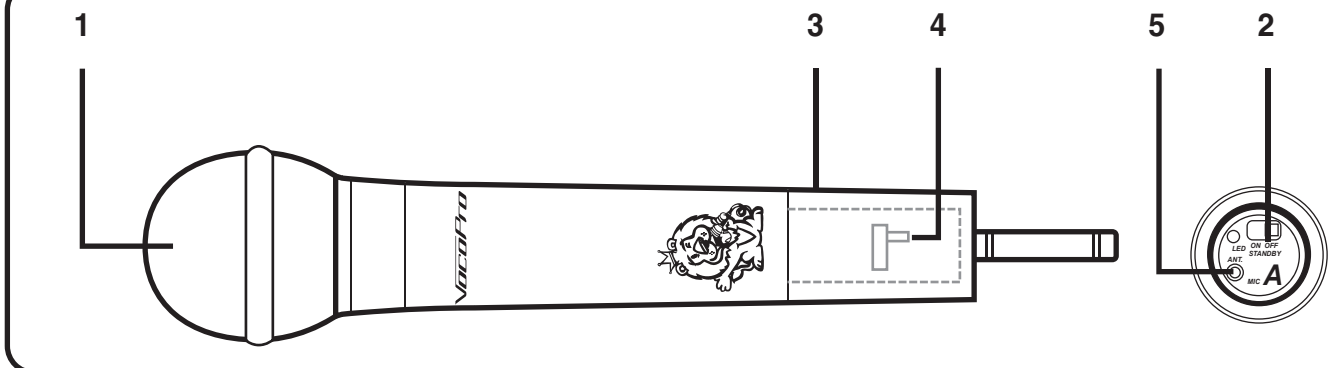

1. GRILL - Protects the microphone cartridge and helps reduce "breathy" and wind noise pick-up.
2. POWER switch - Used to turn the microphone ON/OFF and place in STANDBY.
3. BATTERY COMPARTMENT lid - Removable lid hides and protects the microphone battery.
4. CHANNEL selector (internal) - Used to sync the Mic transmitters outgoing frequency with the receivers channels pre-set for Mic operation. For each Mic [A-B], the channel setting must be set to the same number on the Mic as it is on the receiver. For example, MIC's A and B = Mic channel setting 1, Receiver channel setting = 1.
5. ANTENNA terminal - Accepts the Mic transmitter ANTENNA used for UHF transmission.

Handheld Microphone Antenna Installation

1. Screw the ANTENNA into the ANTENNA TERMINAL on the bottom of each Mic transmitter.

Handheld Microphone Battery Installation

2. Unscrew the microphones BATTERY COMPARTMENT LID located at the bottom of the microphone.
3. Insert 3 fresh 1.5-volt alkaline BATTERIES, being sure to observe proper battery polarity.
4. Re-tighten the BATTERY COMPARTMENT LID.

Battery Installation

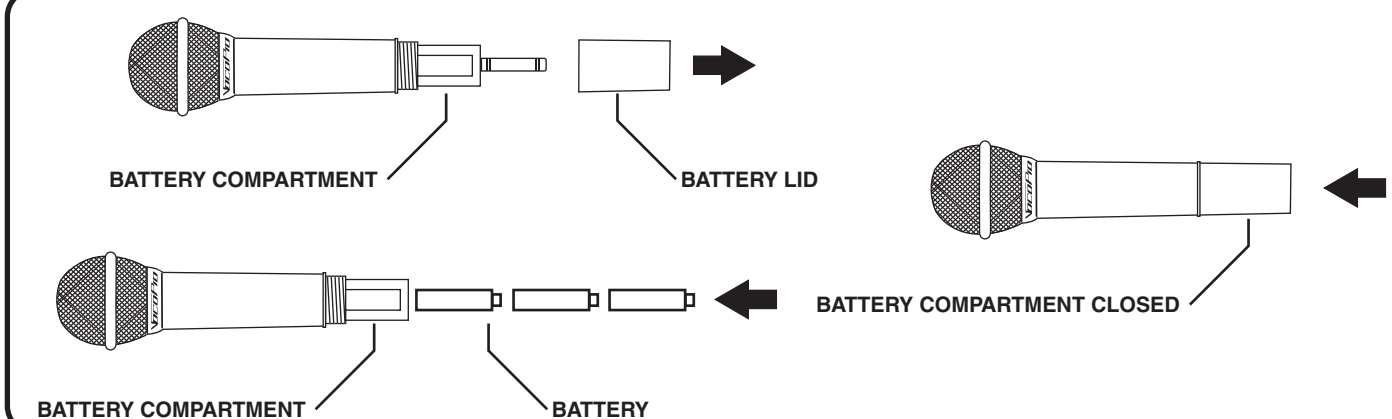

Mounting

To install the UHF-3800 to a 19" rack case, complete the steps below.

1. Attach mounting brackets to the UHF-3800 via the supplied mounting screws.
2. Align the UHF-3800 with desired space in rack and slide in slowly, rear panel first.

NOTE: Depending on your rack case design, it may be necessary to allow for sufficient space for the antennas.

3. While aligned, use rack case screws (not included) in the order shown below to stabilize the UHF-3800 in its space, using the "X" rotation (numbered below) will ensure even tension and flush alignment.

NOTE: Do not tighten screws firmly until all screws are in place.

(See diagram below)

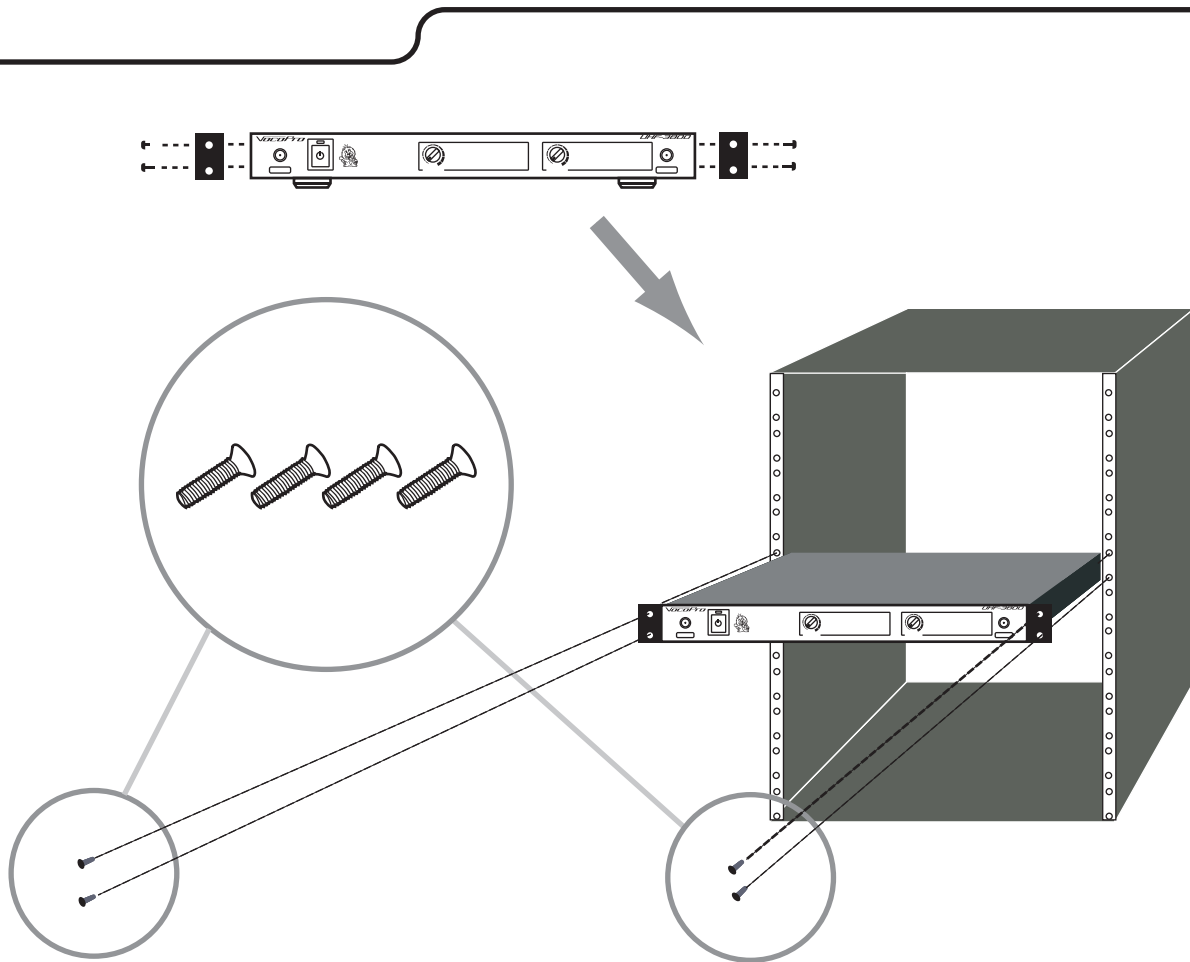

Getting Connected

System Connection

1. Connect the AC POWER ADAPTER to the UHF-3800 receiver's POWER INPUT connector; then plugging the ADAPTER into a compatible AC electrical outlet.
2. Connect the UHF-3800s receiver to a sound system, mixer or amplifier's microphone input(s) with either one ¼" output jack for a mixed channel output, or both XLR output jacks for separate output.

Separated or Mixed Output

	Pros	Cons
Mixed Channel Output	Uses only 1 mic input on an external mixer/amplifier	External mic adjustments applied to just one mic channel
Separate Channel Output	External mic adjustments can be applied on one or both mic channels	Uses 2 mic inputs on mixer/amplifier

Getting Connected

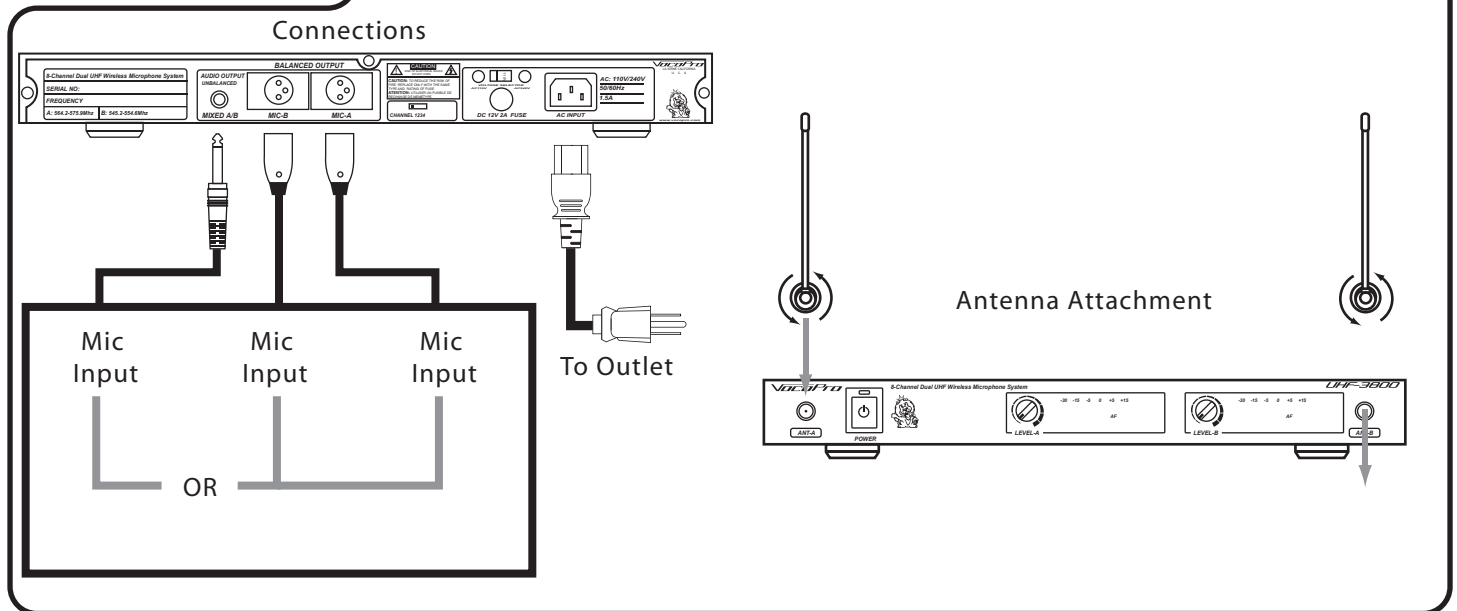

Antenna Connection

1. Insert the ANTENNAS BNC connector into the BNC jack and twist counter-clockwise until it locks into place.

Operations

1. Press the POWER button on the UHF-3800 receiver's front panel. The power LED on the receiver will glow BLUE.
2. Adjust the receiver's VOLUME controls to approximately 50%.
3. Switch the microphone's POWER BUTTONS to the ON positions.
4. Talk or sing into the microphones. During normal operation, the RF/AF signal LED's will light RED when a microphone is being used.
5. Adjust the receiver's VOLUME controls until the output levels are balanced with each other and other possible source output i.e. CD+G tracks. In most cases, the VOLUME controls should be set to +/-65%.

Receiver Volume Adjustment

The VOLUME controls on the front panel of the UHF-3800 receiver can be adjusted to set the wireless system OUTPUT levels as you desire. After making any musical balancing adjustments, adjust the receiver volume control until the output reaches the desired level. Perform this with both MIC channels if they are both to be in use. Rotate the volume control clockwise to increase output. Rotate it counterclockwise to decrease output.

Tips for Achieving Optimum Performance

Recognizing Interference

The ways of recognizing the type of interference present are observing the RF/AF LED indications and carefully listening to the audio output. A set of headphones can be a useful tool in isolating and analyzing interference problems. With headphones it is easier to listen to one wireless channel at a time, even when the system is in use.

Below are some common interference descriptions. Most likely, one of the below descriptions matches the symptoms that you may be experiencing.

- If there is interference when the microphones are off, and the noise/distortion is present from the receiver output when the microphones are powered on, try turning off all other wireless microphones. If the interference problem is still present, there might be a direct radio interference problem. Direct interference is a serious problem that must be corrected in order for the wireless system to be fully usable.
- Interference in the form of low level-audio tones, whines, whining sounds whose pitch changes rapidly, or audible voices or music (distorted or not) is likely to be caused by intermodulation, non-wireless interference or direct interference.
- If there is interference when the receiver is turned on, in the form of buzzy or raspy whines with a distinct cadence or rhythm that differs from time to time, digital interference might be the problem. Common sources include computers, digital delays, effects processors, lighting controllers, and other digital equipment using microprocessors and digital signal processors (DSPs).
- If there is no interference when the receiver is turned off and irregular popping, cracking or buzzing noises on the audio with the receiver on, there may be electrical interference problems. This kind of interference is usually caused by electric motors, neon lights, lighting equipment, appliances and other types of electrical equipment. Electrical interference will generally affect all wireless systems at a location, not just one system.
- Certain types of buzzing sounds are actually due to interference from TV stations. If the buzzing sound changes substantially at more or less random intervals and does not seem to be caused by electrical equipment, the problem may be TV interference.
- Interference that takes the form of bursts of static or short bursts of noise is likely to be caused by lightning, intermittent arcing or defective electrical machinery. This type of random interference is quite rare but can be among the most difficult to resolve.

(cont.)

Tips for Achieving Optimum Performance (cont.)

If none of the descriptions matches your particular problem, or the information is unclear, see the "Avoiding Basic Problems/UHF Frequency Conflicts" sections below. Your authorized dealer may also be able to offer assistance and might be familiar with any unusual local conditions that could be affecting the problem. If your dealer is not able to assist, owners of VocoPro equipment can obtain telephone support at: 800-678-5348 9A-5P M-F Pacific Time.

Avoiding Basic Problems

Sometimes interference problems have very basic causes. To avoid wasting time on an easily correctable problem, check the following items before proceeding:

- Make certain that no radio transmitters are allowed to come closer than approximately 10 to 15 feet of the wireless receiver antennas. This can overload the receiver and increase the chances of interference.
- Make certain not to allow receiver antennas to touch each other when arranging them. Try to provide at least 10 inches of separation between the antennas of any two receivers.
- Make sure that all microphones have charged batteries. The low output voltage of weak batteries can cause some microphones to generate harmful interference. If there is any doubt, install fresh batteries in all microphones.
- Make sure that the wireless frequencies are not on a local TV channel.
- Check the wireless frequencies in use to make sure that no two systems are on the same frequency.
- Check to make sure that no two wireless frequencies are too close together. In general, 1 MHz is the recommended minimum spacing between systems.
- If a considerable number of systems will be used, operating conditions will be difficult or interference is likely, if possible avoid these situations.
- Before using a system in a new location or another city, double-check for new problems. Small changes in conditions can cause interference where none was present before.
- Turn off unnecessary electronic equipment, especially computers and digital devices. These are a relatively common cause of wireless interference.
- If use of computers or digital devices is necessary, keep them at least 18 inches (45 cm) away from the microphones and receiver antennas.

UHF Frequency Conflicts

The primary way that UHF wireless systems experience interference, is direct frequency conflict. If two UHF wireless systems are on the same frequency, usually neither system will be usable unless the other is turned off. This problem is not as common as might be expected, due to the non-crowded nature of the UHF band and the multi-channel/frequency selection found on many UHF systems.

Troubleshooting

Problems	Solutions
No sound output, RF/AF LED(s) not glowing.	<ul style="list-style-type: none"> • Make sure the microphone and receiver power switches and receiver are set to the ON position. • Check microphone batteries to ensure that they are providing sufficient power. Replace battery if necessary. • Check receiver's AC power connection. • Make sure antennas are firmly connected and extended to an optimal position. • If necessary, reduce the distance between the microphones and receiver. • Turn up the receiver's VOLUME level controls. • Check for proper connection between receiver and external amplifier/mixer. • Talk into the microphone and observe the receiver's RF/AF signal LED's. If they glow, the problem is elsewhere in the sound system.
Received signal is noisy or contains extraneous sounds with the microphone(s) ON.	<ul style="list-style-type: none"> • Check microphone(s) batteries and replace if charge is low. • Remove local sources of UHF interference, such as lighting equipment. • Signal may be too weak. If so, reposition antennas. (If possible, move them closer to the transmitter).
Noise coming from the receiver with the microphones turned OFF.	<ul style="list-style-type: none"> • Remove local sources of UHF interference, such as lighting equipment. • Reposition the receiver or antennas.
Momentary loss of sound as microphone(s) are moved throughout the operating range.	<ul style="list-style-type: none"> • Reposition the receiver, perform a "walkthrough", and observe the signal strengths. If audio dropouts persist, mark these "dead spots" in the operating area and avoid them during the performance.

Specifications

RF Carrier Frequency Channel

520M-570M(8 channels, work at the same time)

If the user has a special demand, we can have the frequency made to order.

Service Area:

100m(ground)

Transmit

Frequency Response:

Audio-head FR: 50-16kHz±3dB

Without Audio-head FR: 20-20kHz±3dB

Modulation:

±75kHz

RF Power:

20mW

Dynamic Area:

>102dB

Electric Level Output:

Typical±5dBu(unbalanced output)

Typical±14dBu(balanced output)

Polarity(Microphone):

Exert pressure at the front of cartridge, to generate electric pressure.

Receiver

Sensitivity:

0.2 V(@12dB SinAD)

Pseudomorph Modulation:

Typical 90dB

Stray modulation:

Typical 75dB

Limited Mute:

>100dB(15kHz Frequency offset)

System Distortion:

0.3% Total harmonic distortion, Typical, @1kHz signal 4.5kHz frequency offset.

Battery

Handheld Microphone:

1.5V AA battery

Receiver:

110V-220V (with changeover switch)

Service life of battery:

1.5V AA high-energy battery can be worked more than 13hrs.

Working Temperature:

-20°C-50°C(Make sure the battery can exceed this norm.)

UHF-3800 Owner's Manual version 2
© VocoPro 2007



www.vocopro.com

VocoPro

ULTIMATE CHOICE OF KARAOKE ENTERTAINMENT