

# VocoPro®

PROFESSIONAL VOCAL SYSTEMS™

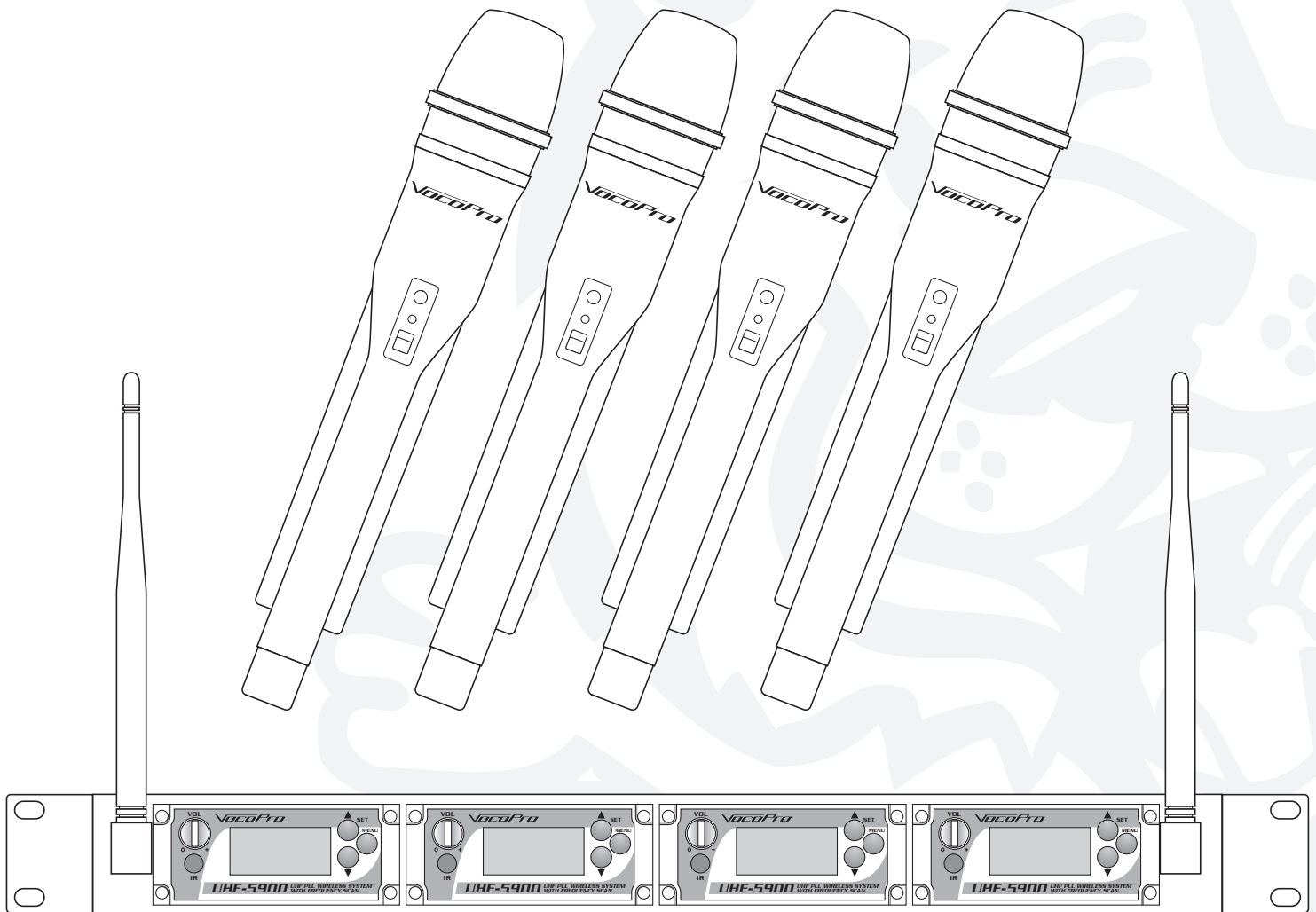

## **UHF-5900**

**UHF PLL WIRELESS MIC SYSTEM WITH FREQUENCY SCAN**

o w n e r ' s m a n u a l

## Table of Contents

Safety Instructions . . . . .	3
FCC Information . . . . .	4
Welcome. . . . .	5
Listening for a Lifetime . . . . .	6
Features . . . . .	7
Getting Connected . . . . .	8-9
Descriptions and Functions . . . . .	10-12
Setting up the Microphones . . . . .	13-15
Basic Operations . . . . .	16-17
Advanced Operations. . . . .	18
Frequency Reference . . . . .	19-20
Troubleshooting . . . . .	21

# Safety Instructions



## CAUTION RISK OF SHOCK



CAUTION: To reduce the risk of electric shock, do not remove cover (or back). No user-serviceable parts inside. Only refer servicing to qualified service personnel.

### Explanation of Graphical Symbols



The lightning flash & arrowhead symbol, within an equilateral triangle, is intended to alert you to the presence of danger.



The exclamation point within an equilateral triangle is intended to alert you to the presence of important operating and servicing instructions.

### WARNING

To reduce the risk of fire or electric shock, do not expose this unit to rain or moisture.

- 1. Read Instructions** - All the safety and operating instructions should be read before the appliance is operated.
- 2. Retain Instructions** - The safety and operating instructions should be retained for future reference.
- 3. Heed Warnings** - All warnings on the appliance and in the operating instructions should be adhered to.
- 4. Follow Instructions** - All operating and use instructions should be followed.
- 5. Attachments** - Do not use attachments not recommended by the product manufacturer as they may cause hazards.
- 6. Water and Moisture** - Do not use this unit near water. For example, near a bathtub or in a wet basement and the like.
- 7. Carts and Stands** - The appliance should be used only with a cart or stand that is recommended by the manufacturer.
- 7 A.** An appliance and cart combination should be moved with care. Quick stops, excessive force, and uneven surfaces may cause an overturn. 
- 8. Ventilation** - The appliance should be situated so its location does not interfere with its proper ventilation. For example, the appliance should not be situated on a bed, sofa, rug, or similar surface that may block the ventilation slots.
- 9. Heat** - The appliance should be situated away from heat sources such as radiators, heat registers, stoves, or other appliances (including amplifiers) that produce heat.
- 10. Power Sources** - The appliance should be connected to a power supply only of the type described in the operating instructions or as marked on the appliance.
- 11. Grounding or Polarization** - Precautions should be taken so that the grounding or polarization means of an appliance is not defeated.
- 12. Power-Cord Protection** - Power-supply cords should be routed so that they are not likely to be walked on or pinched by items placed upon or against them, paying particular attention to cords at plugs, convenience receptacles, and the point where they exit from the appliance.
- 13. Cleaning** - Unplug this unit from the wall outlet before cleaning. Do not use liquid cleaners or aerosol cleaners. Use a damp cloth for cleaning.
- 14. Power lines** - An outdoor antenna should be located away from power lines.
- 15. Nonuse Periods** - The power cord of the appliance should be unplugged from the outlet when left unused for a long period of time.
- 16. Object and Liquid Entry** - Care should be taken so that objects do not fall and liquids are not spilled into the enclosure through openings.
- 17. Damage Requiring Service** - The appliance should be serviced by qualified service personnel when:
  - A. The power supply cord or plug has been damaged; or
  - B. Objects have fallen into the appliance; or
  - C. The appliance has been exposed to rain; or
  - D. The appliance does not appear to operate normally or exhibits a marked change in performance; or
  - E. The appliance has been dropped, or the enclosure damaged.
- 18. Servicing** - The user should not attempt to service the appliance beyond that described in the operating instructions. All other servicing should be referred to qualified service personnel.

#### Note:

To CATV system installer's (U.S.A.): This reminder is provided to call the CATV system installer's attention to Article 820-40 of the NEC that provides guidelines for proper grounding and, in particular, specifies that the cable ground shall be connected as close to the point of cable entry as practical.

# FCC Information

## 1. IMPORTANT NOTICE: DO NOT MODIFY THIS

**UNIT!:** This product, when installed as indicated in the instructions contained in this manual, meets FCC requirements. Modifications not expressly approved by Vocopro may void your authority, granted by the FCC, to use this product.

**2. IMPORTANT:** When connecting this product to accessories and/or another product use only high quality shielded cables. Cable(s) supplied with this product **MUST** be used. Follow all installation instructions. Failure to follow instructions could void your FCC authorization to use this product in the U.S.A.

**3. NOTE:** This product has been tested and found to comply with the requirements listed in FCC Regulations, Part 15 for Class "B" digital devices. Compliance with these requirements provides a reasonable level of assurances that your use of this product in a residential environment will not result in harmful interference with other electronic devices. This equipment generates/uses radio frequencies and, if not installed and used according to the instructions found in the owner's manual, may cause interference harmful to the operation of other electronic devices. Compliance with FCC regulations does not guarantee that interference will not occur in all installations. If this product is found to be the source of interference, which can be determined by turning the unit "Off" and "On", please try to eliminate the problem by using one of the following measures:

Relocate either this product or the device that is being affected by the interference.

Use power outlets that are on different branch (circuit breaker or fuse) circuits or install AC line filter(s).

In the case of radio or TV interference, relocate/reorient the antenna. If the antenna lead-in is 300-ohm ribbon lead, change the lead-in to coaxial type cable.

If these corrective measures do not produce satisfactory results, please contact your local retailer authorized to distribute Vocopro products. If you can not locate the appropriate retailer, please contact Vocopro, 1728 Curtiss Court, La Verne, CA 91750.

## CAUTION

The apparatus is not disconnected from the AC power source so long as it is connected to the wall outlet, even if the apparatus itself is turned off. To fully ensure that the apparatus is indeed fully void of residual power, leave unit disconnected from the AC outlet for at least fifteen seconds.

## CAUTION:

### READ THIS BEFORE OPERATING YOUR UNIT

1. To ensure the finest performance, please read this manual carefully. Keep it in a safe place for future reference.
2. Install your unit in a cool, dry, clean place - away from windows, heat sources, and too much vibration, dust, moisture or cold. Avoid sources of hum (transformers, motors). To prevent fire or electrical shock, do not expose to rain and water.
3. Do not operate the unit upside-down.
4. Never open the cabinet. If a foreign object drops into the set, contact your dealer.
5. Place the unit in a location with adequate air circulation. Do not interfere with its proper ventilation; this will cause the internal temperature to rise and may result in a failure.
6. Do not use force on switches, knobs or cords. When moving the unit, first turn the unit off. Then gently disconnect the power plug and the cords connecting to other equipment. Never pull the cord itself.
7. Do not attempt to clean the unit with chemical solvents; this might damage the finish. Use a clean, dry cloth.
8. Be sure to read the "Troubleshooting" section on common operating errors before concluding that your unit is faulty.
9. This unit consumes a fair amount of power even when the power switch is turned off. We recommend that you unplug the power cord from the wall outlet if the unit is not going to be used for a long time. This will save electricity and help prevent fire hazards. To disconnect the cord, pull it out by grasping the plug. Never pull the cord itself.
10. To prevent lightning damage, pull out the power cord and remove the antenna cable during an electrical storm.
11. The general digital signals may interfere with other equipment such as tuners or receivers. Move the system farther away from such equipment if interference is observed.

## NOTE:

Please check the copyright laws in your country before recording from records, compact discs, radio, etc. Recording of copyrighted material may infringe copyright laws.

## Voltage Selector (General Model Only)

Be sure to position the voltage selector to match the voltage of your local power lines before installing the unit.

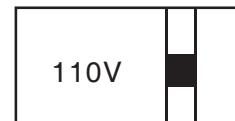



## Welcome

And thank you for purchasing the **UHF-5900** from VocoPro, your ultimate choice in vocal entertainment! With years of experience in the music entertainment business, VocoPro is a leading manufacturer of vocal equipment, and has been providing patrons of bars, churches, schools, clubs and individual consumers the opportunity to sound like a star with full-scale club models, in-home systems and mobile units. All our products offer solid performance and sound reliability, and to reinforce our commitment to customer satisfaction, we have customer service and technical support professionals ready to assist you with your needs. We have provided some contact information for you below.

### VocoPro

1728 Curtiss Court  
La Verne, CA 91750  
**Toll Free: 800-678-5348**  
TEL: 909-593-8893  
FAX: 909-593-8890

#### VocoPro Company Email Directory

#### Customer Service & General Information

info@vocopro.com

#### Tech Support

techsupport@vocopro.com

#### Remember Our Website

Be sure to visit the VocoPro website **www.vocopro.com** for the latest information on new products, packages and promos. And while you're there don't forget to check out our Club VocoPro for Karaoke news and events, chat rooms, club directories and even a KJ Service directory!

We look forward to hearing you sound like a PRO, with VocoPro, the singer's ultimate choice.

### FOR YOUR RECORDS

Please record the model number and serial number below, for easy reference, in case of loss or theft. These numbers are located on the rear panel of the unit. Space is also provided for other relevant information

**Model Number**

**Serial Number**

**Date of Purchase**

**Place of Purchase**

# Listening for a Lifetime

Selecting fine audio equipment such as the unit you've just purchased is only the start of your musical enjoyment. Now it's time to consider how you can maximize the fun and excitement your equipment offers. VocoPro and the Electronic Industries Association's Consumer Electronics Group want you to get the most out of your equipment by playing it at a safe level. One that lets the sound come through loud and clear without annoying blaring or distortion and, most importantly, without affecting your sensitive hearing.

Sound can be deceiving. Over time your hearing "comfort level" adapts to a higher volume of sound. So what sounds "normal" can actually be loud and harmful to your hearing. Guard against this by setting your equipment at a safe level BEFORE your hearing adapts.

To establish a safe level:

- Start your volume control at a low setting.
- Slowly increase the sound until you can hear it comfortably and clearly, and without distortion.

Once you have established a comfortable sound level:

- Set the dial and leave it there.
- Pay attention to the different levels in various recordings.

Taking a minute to do this now will help to prevent hearing damage or loss in the future. After all, we want you listening for a lifetime.

Used wisely, your new sound equipment will provide a lifetime of fun and enjoyment. Since hearing damage from loud noise is often undetectable until it is too late, this manufacturer and the Electronic Industries Association's Consumer Electronics Group recommend you avoid prolonged exposure to excessive noise. This list of sound levels is included for your protection.

## Some common decibel ranges:

Level	Example
<b>30</b>	Quiet library, Soft whispers
<b>40</b>	Living room, Refrigerator, Bedroom away from traffic
<b>50</b>	Light traffic, Normal Conversation
<b>60</b>	Air Conditioner at 20 ft., Sewing machine
<b>70</b>	Vacuum cleaner, Hair dryer, Noisy Restaurant
<b>80</b>	Average city traffic, Garbage disposals, Alarm clock at 2 ft.

## The following noises can be dangerous under constant exposure:

Level	Example
<b>90</b>	Subway, Motorcycle, Truck traffic, Lawn Mower
<b>100</b>	Garbage truck, Chainsaw, Pneumatics drill
<b>120</b>	Rock band concert in front of speakers
<b>140</b>	Gunshot blast, Jet plane
<b>180</b>	Rocket launching pad

-Information courtesy of the Deafness Research Foundation

# Features

## Features

- Operates In The FCC Compliant 600MHz Band
- Includes Four UHF Wireless Microphones
- Frequency Scan Feature Finds Frequencies With The Least Interference
- More Than 150 Wireless Frequencies To Choose From
- LCD Display Windows Show Frequency And Other Information
- 19" Rack Mount Compatible, Uses Only 1 Rack Space
- Independent Channel Power Switches And Volume Controls
- Four XLR Independent Channel Audio Outputs
- One 1/4" Mixed Audio Output
- Microphones Use AA Batteries
- Includes Handy Carrying Case

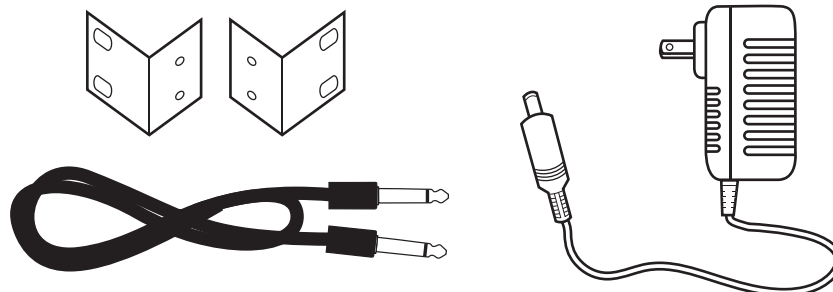
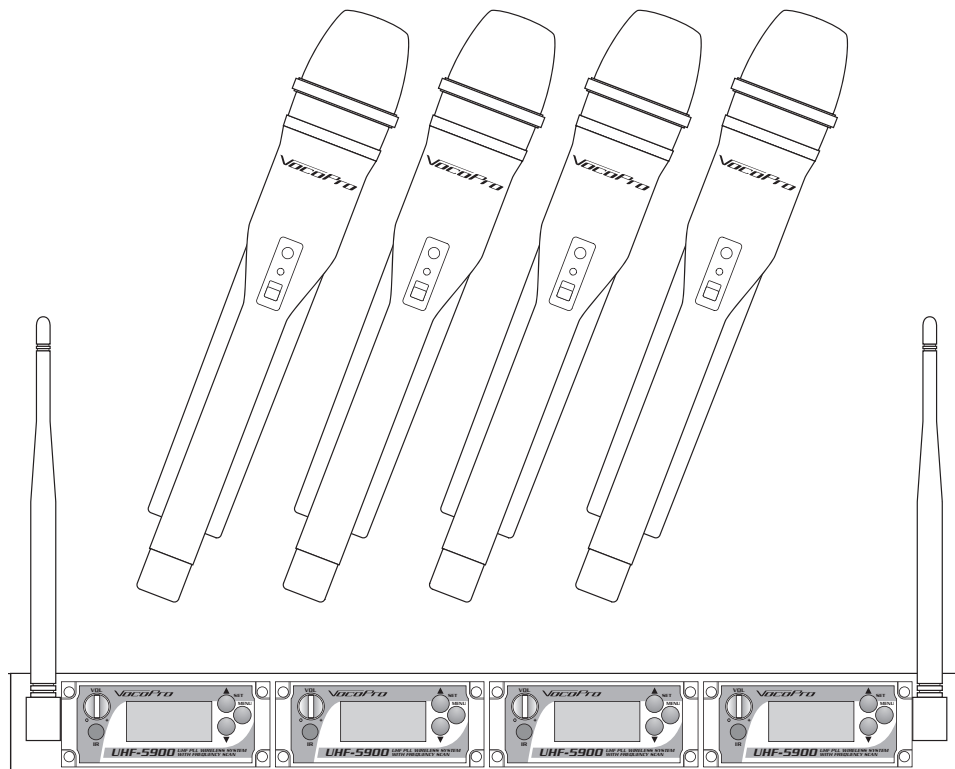

# Getting Connected

## Connecting Power

1. Ensure the main power switch on the rear panel is set to OFF.
2. Connect the power adapter to the power input on the rear panel.
3. Plug the power adapter into a power outlet, or a surge protector.

NOTE: A surge protector is recommended to protect your equipment from power surges.

## Connecting Audio

### Using the XLR outputs

The XLR outputs allow you to connect each microphone channel separately to a mixer. This gives you more control over the sound of the individual channels when they are connected to your mixer.

You will need:

- UHF-5900
- 4 XLR patch cables (not included)
- An input device, such as a mixer or amplifier

To Connect the XLR outputs:

1. Ensure the main power switch on the rear panel is turned off.
2. Connect one end of an XLR cable to the channel 1 output of the UHF-5900.
3. Connect the other end of the XLR cable to the desired input on your mixer.

NOTE: To avoid confusion, it's recommended that you plug channel 1 to input 1, channel 2 to input 2, and so forth. The illustrated setup is for visual clarity only.

4. Repeat steps 2 and 3 until all the XLR outputs are connected.

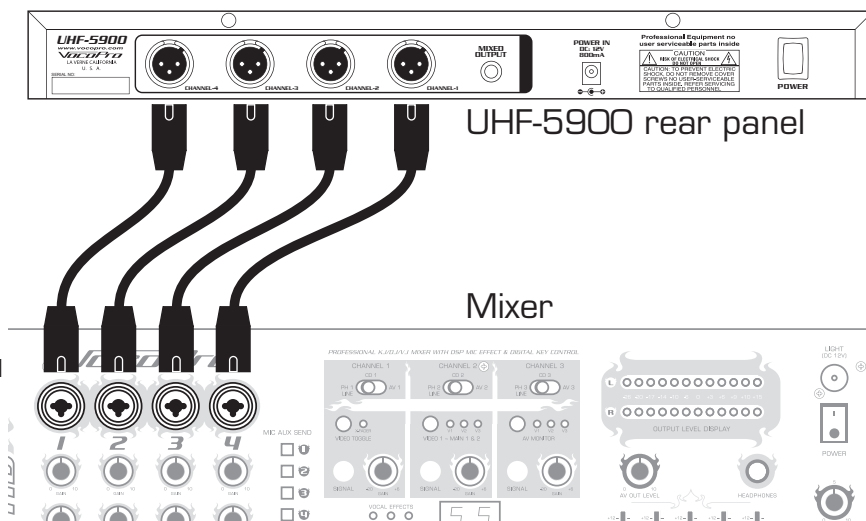

### Using the 1/4" mixed output

The 1/4" mixed output is useful if you do not have a mixer, or if you have limited inputs available on your mixer. All four microphone signals are mixed together in this output.

You will need:

- UHF-5900
- 1/4" patch cable
- An input device, such as a mixer or amplifier

To Connect the 1/4" output:

1. Ensure the main power switch on the rear panel is turned off.
2. Connect one end of a 1/4" cable to the 1/4" mixed output on the rear panel of the UHF-5900.
3. Connect the other end of the 1/4" cable to the desired input on your mixer or amplifier.

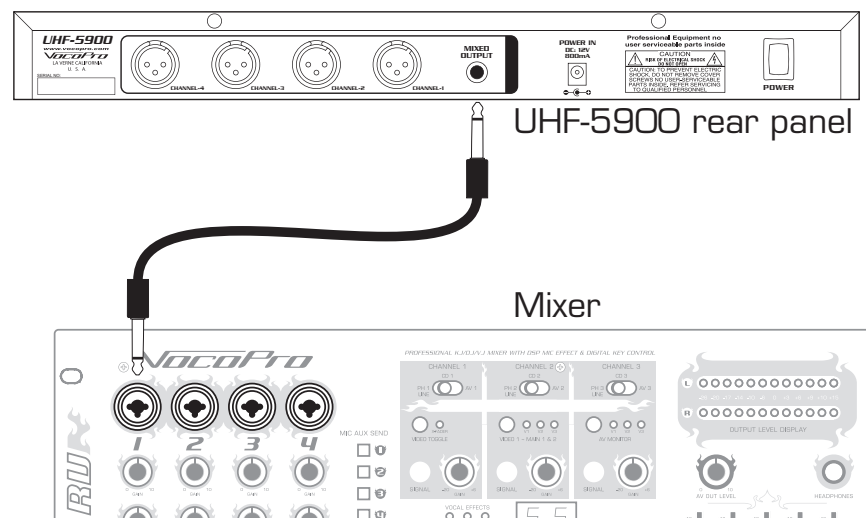



# Getting Connected

## Connecting Antennas

The Antennas receive the UHF wireless signals from the microphones.

1. Attach the antennas to the connectors on the front panel by twisting them clockwise until firmly attached.
2. To disconnect the antennas, twist counter-clockwise.

## Attaching the Rack Brackets

The UHF-5900 comes with detachable rack brackets which allows the unit to be installed in a standard 19 inch rack.

1. Use the included screws to fasten the rack brackets to the sides of the UHF-5900 as shown in the illustration below.

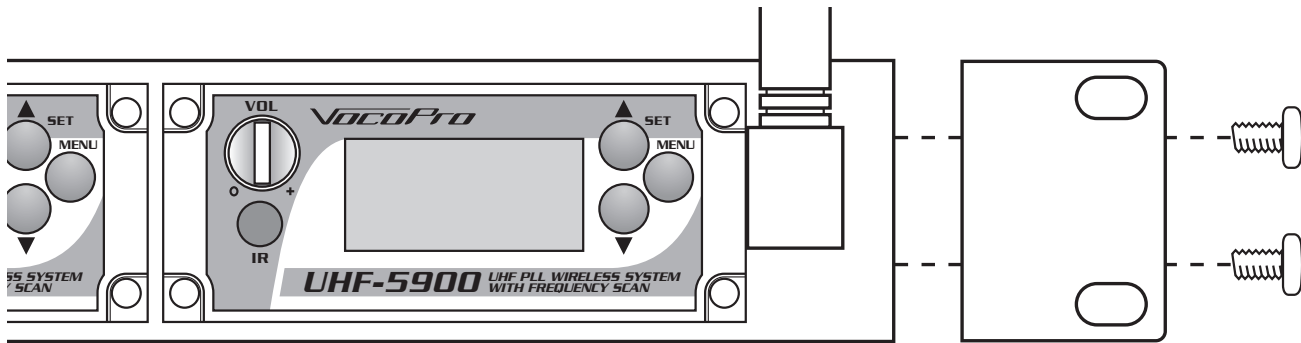

## Mounting the UHF-5900 in a Rack

The UHF-5900 will fit in a standard 19" rack (not included).

1. Align the UHF-5900 with the desired space in rack and slowly slide in, rear panel first.  
NOTE: Depending on your rack case design, it may be necessary to allow for sufficient space for the antennas.
2. While aligned, use rack case screws (not included) in the order shown below to stabilize the UHF-5900 in its space, using the "X" rotation (numbered below) will ensure even tension and flush alignment.  
NOTE: Do not tighten screws firmly until all screws are in place.

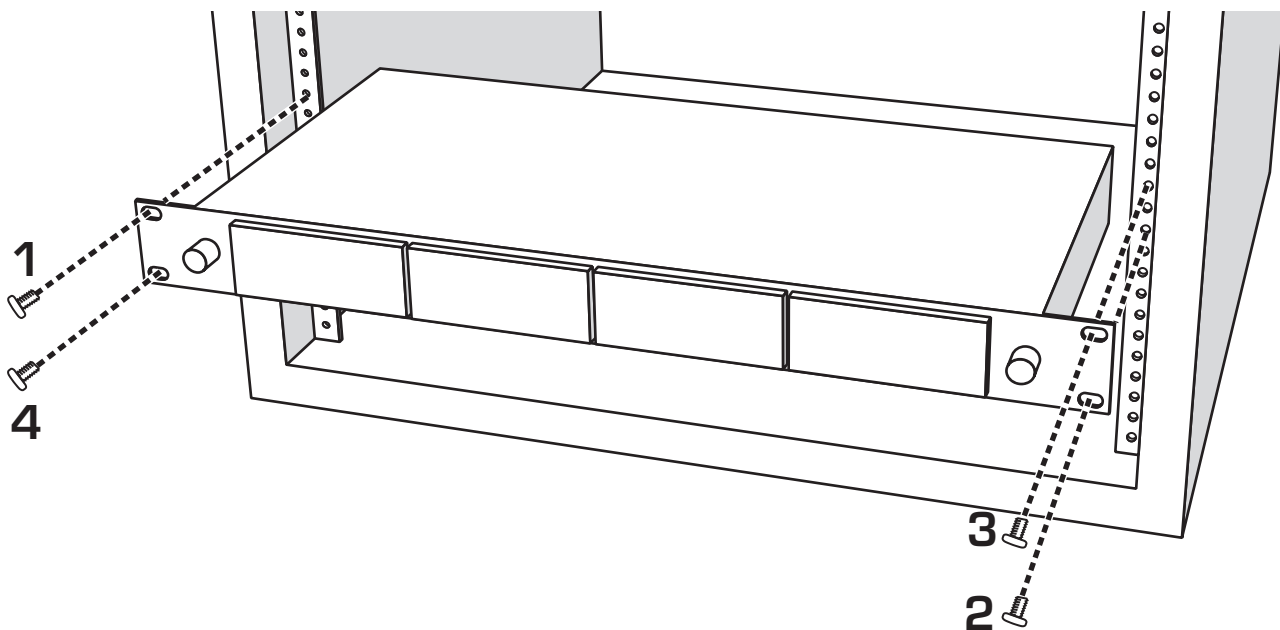

# Descriptions and Functions

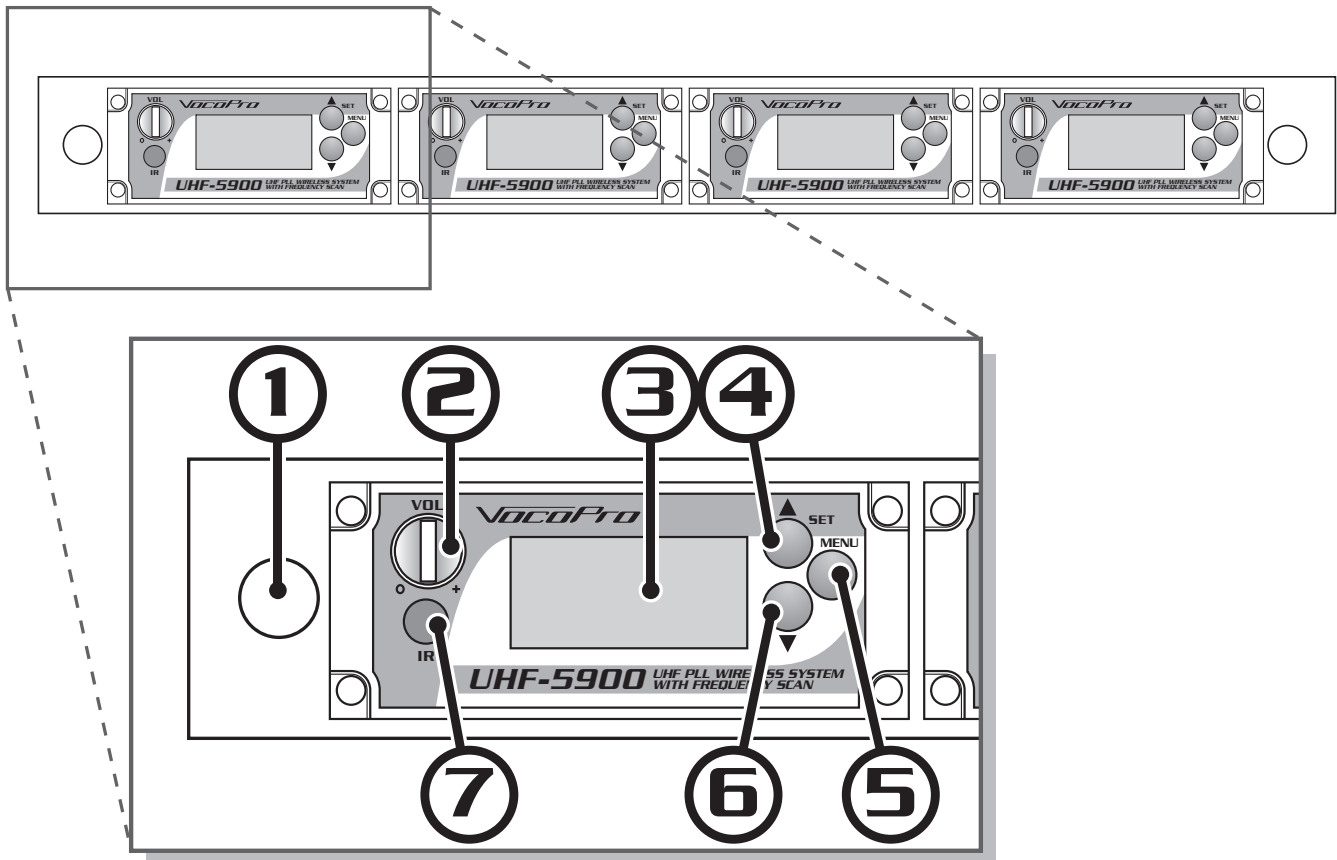

## Front Panel

- 1. Antenna Connector** - Connect the antennas to these connectors to receive the wireless signals from the microphones.
- 2. Module Volume/On-Off Knob** - This dual purpose knob controls the volume of this module. Turning the knob clockwise will increase the volume, turning counter-clockwise will decrease it. Turning the knob counter-clockwise until it clicks will switch the power off on this module. Turn it clockwise to switch the module on.
- 3. Module Display Window** - This LCD screen displays information about this module. See the Module Display Window descriptions and functions for more details.
- 4. Up/Set Button** - While in menu mode, press this button to change or set the selected menu item. While not in menu mode, press and hold this button to increase the squelch.
- 5. Menu Button** - Press this button to toggle through the different menu modes.
- 6. Down Button** - While in menu mode, press this button to change the selected menu item. While not in menu mode, press and hold this button to decrease the squelch.
- 7. IR (infrared) Transmitter** - This transmitter is used to communicate with the microphone while setting the frequency. While in IR mode, it will transmit an IR (infrared) signal which tells the microphone which frequency to use.  
NOTE: The IR transmitter is used only during microphone frequency setup. It does not transmit or receive audio signal.

# Descriptions and Functions

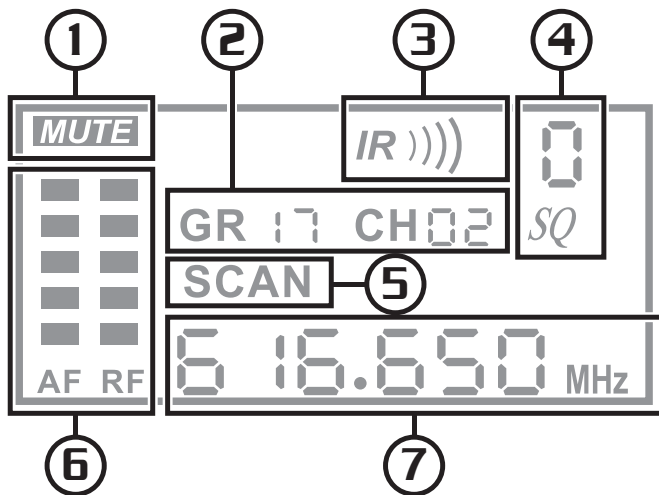

## Module Display Window

1. **MUTE Indicator** - Shows when this module is in MUTE mode. The module automatically switches to mute mode when its paired microphone is turned OFF.
2. **Group and Channel** - Displays the group and channel that this module is currently set to.
3. **IR (infrared) Mode Indicator** - Shows when this module is in IR (infrared) mode, which is used assign a microphone to this module's frequency.
4. **Squelch** - Displays the current squelch level for this module. See Using the Squelch Control in the operations section.
5. **SCAN Mode Indicator** - Shows when this module is in SCAN mode, which is used to search for an interference free frequency.
6. **AF and RF Level Bars** - The RF bar shows the strength of the wireless signal from the microphone. The AF bars show when this module is receiving audio signals from the microphone.
7. **Channel Frequency** - Displays what frequency this module is currently set to.

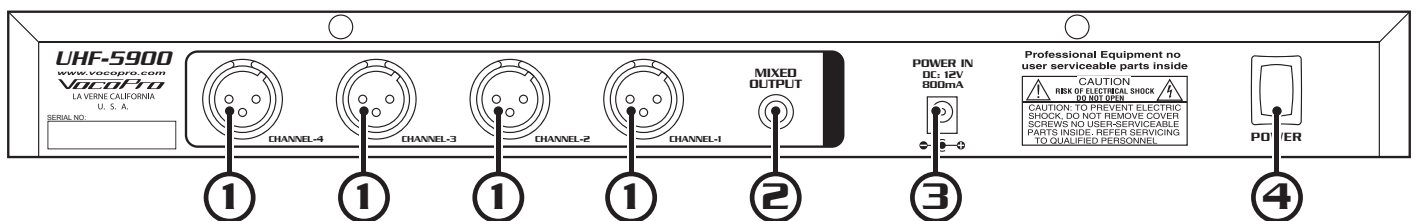

## Rear Panel

1. **Independent XLR Channel Outputs** - These four balanced jacks output audio from each module independently.
2. **Mixed Audio Output** - This unbalanced jack outputs the audio of all the modules mixed together.
3. **Power Adapter Plug** - Attach the power adapter here to provide power to the unit.
4. **Main Power Switch** - This switch turns the power on and off for the whole unit.

# Descriptions and Functions

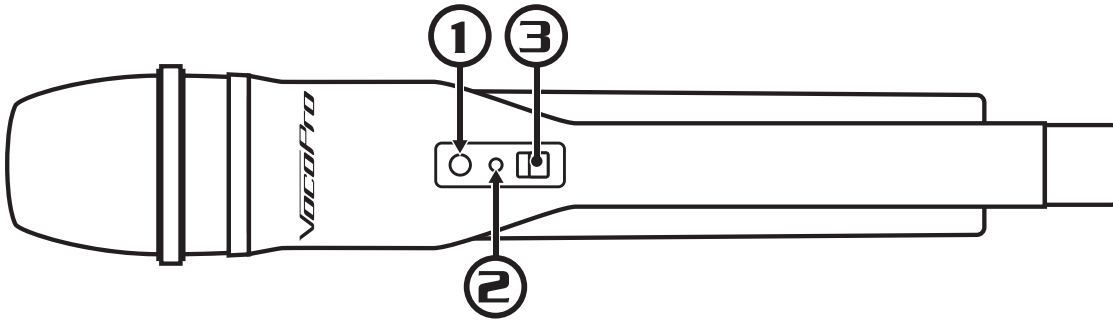

## Microphones

1. **IR (infrared) Sensor** - This sensor receives the infrared signal that is used to set the frequency that the wireless mic will use. This sensor is only used to set the microphone frequency, it does not send or receive audio signal.
2. **Power LED** - This LED indicator will turn green when the microphone is turned on. It will turn red when the batteries need to be replaced.
3. **ON/OFF Switch** - This switch turns the microphone on or off.

### Installing the Batteries

To install the wireless mic batteries:

1. Remove the battery cover.
2. Insert two fresh AA batteries. Make sure they are facing the correct direction.
3. Replace the battery cover.

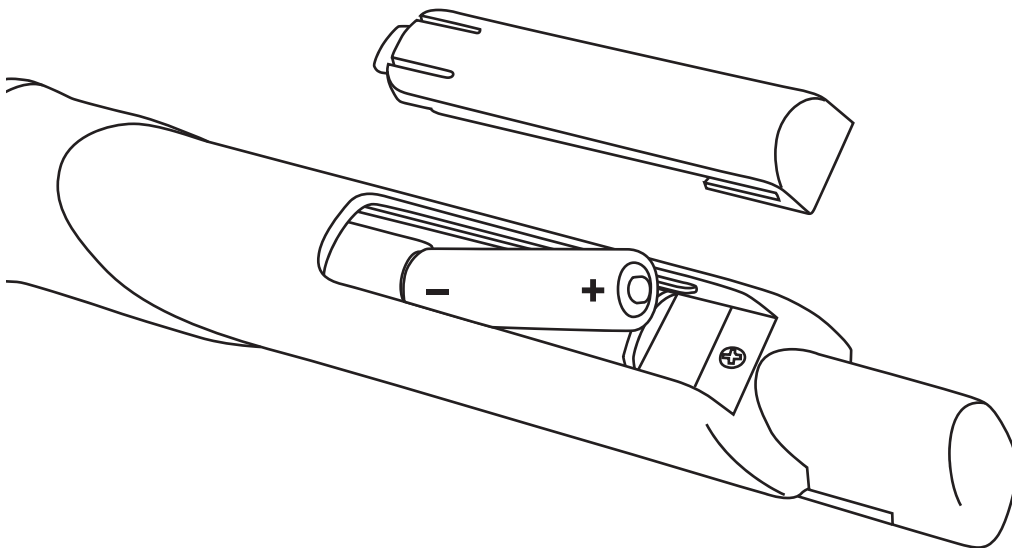

# Setting up the Microphones

## Overview

The goal is for each of the UHF-5900's wireless channels to be operating on a frequency free of interference. This can be accomplished two ways 1) automatic frequency selection, and 2) manual frequency selection. We recommend using the automatic method first, as this method will work well for most areas. However, if you live in a metropolitan area where RF activity is dense, manual frequency selection may work better for you. If you choose the manual method, we recommend first obtaining information on your proximity to TV towers. (see page 18)

## Frequencies and Groups

The UHF-5900 has a total of 177 available frequencies. These frequencies are broken down into groups. The two channels on the left are assigned GROUPS GR1-1 through GR1-C, while the two channels on the right are assigned GROUPS GR2-1 through GR2-C (see chart on page19).

## Pressing Buttons: 5 Second Default

When cycling through the selection modes and parameters using the MENU, UP, & DOWN buttons, if a selection is not made within 5 seconds, the system will automatically start the auto-scan sequence. So, let's say you are trying to change to a channel in a different group. After pressing MENU, you have only 5 seconds to press the UP/DOWN arrows to browse through the available groups. This applies to every step of the frequency setup procedure, so keep this in mind. If this happens, simply wait for it to finish and resume where you left off.

## Other Devices

Be sure to power on any other devices that may potentially interfere with the UHF-5900 (other wireless systems) BEFORE you begin the frequency selection process. This way, you will not have any surprises when they are powered on.

## Antenna Positioning

For the best reception, position the receiver antennas at 90 degrees from each other. (see illustration).

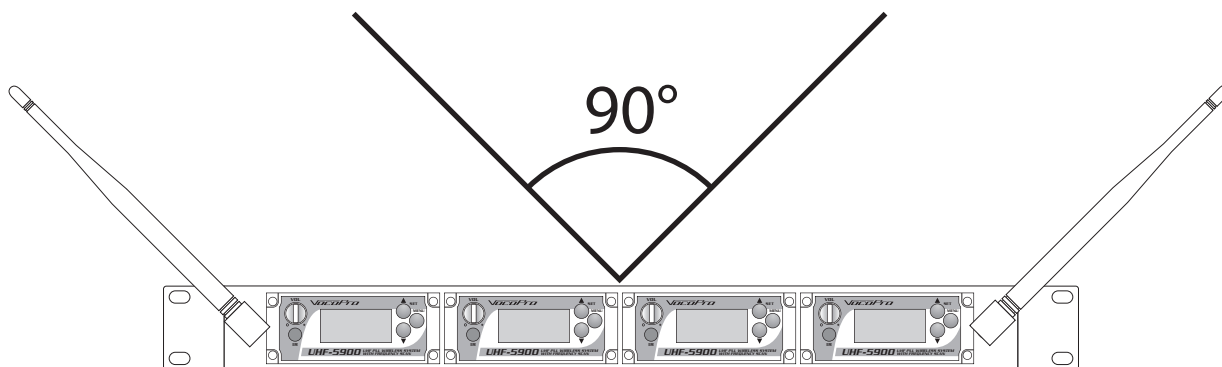

# Setting up the Microphones

## Setting the Frequencies Automatically

The wireless mics can be set to a frequency automatically using the frequency scan function. Automatic setup is easy, and is recommended for most areas. If you live in a metropolitan area, it might be necessary to use the manual setup process.

### AUTOMATIC SETUP

Setting up the microphones using the frequency scan function.

- 1. Prepare the System:** Ensure the main power switch on the rear panel is turned ON. Ensure the module is turned ON. Ensure the desired microphone is turned ON.  
**Note:** The automatic process happens quickly, so it's a good idea to have the mic on and in hand during this process.
- 2. Select a Group:** Press the MENU button on the module until "GR" is visible in the display window. Then press the up and down buttons to select a group. After 5 seconds the unit will automatically scan for an available frequency, and then switch to mic program mode. Have the mic on and ready for the next step.
- 3. Program the Mic:** While the IR icon appears on the screen, hold the microphone up to the module about 8 inches away so that the two IR windows are facing each other. Hold the mic there until the RF bars appear in the display window.
- 4. Test the Mic:** Check the microphone by speaking into it. The AF bars in the display window should illuminate when you speak.  
**Note:** After turning on a microphone, there is a 5 second delay before audio transmission. Turn off the microphone (not the module) to test for outside interference. If the RF indicator still has bars showing, interference may be occurring. If this happens, perform an auto-scan on a different group. After each channel is successfully paired, leave both the microphone and module on. This will prevent the next module from thinking that frequency is available. (Be sure to set the mics behind the main unit so they don't get re-programmed)
- 5. Repeat the process** for each remaining mic and module. Once this process is complete, the microphones and modules will remain assigned to these frequencies until you change them.

### Troubleshooting this process:

**The module continues to scan a group:** That group probably has too much interference. Switch the module off and on again and try scanning a different group.

**The RF bars didn't show up and the mic has no audio:** The mic probably didn't get programmed. Make sure nothing is blocking the IR windows, the microphone is switched on, and repeat the process.

**There is still RF interference after auto scanning several different groups:** If you can't seem to find an interference free frequency after scanning several groups, you might be in an area with heavy RF interference. You may need to use the manual frequency selection process. See page 15 for the manual process.

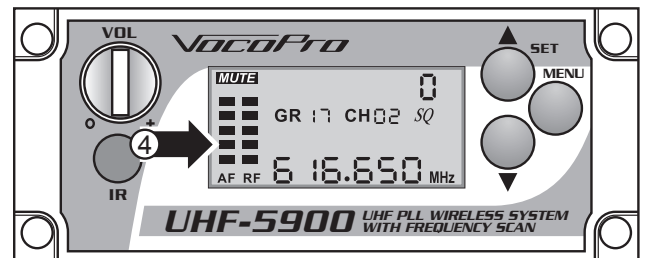
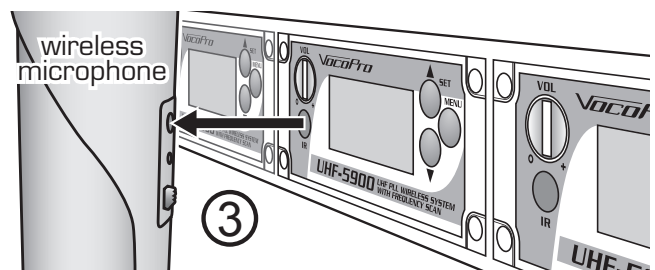
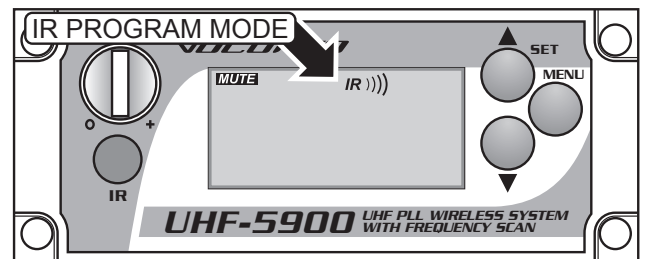
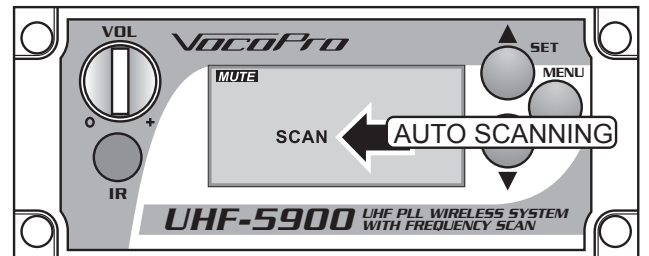
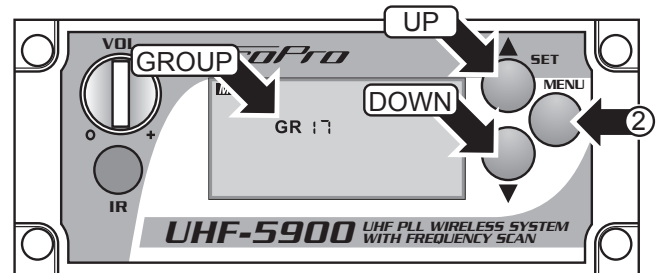

# Setting up the Microphones

## Setting the Frequencies Manually

If you are using the UHF-5900 in a area with heavy RF interference, you may have to set the frequencies manually. Before you start selecting frequencies manually, we recommend that you obtain information on your proximity to TV broadcast towers (see page 18).

### MANUAL SETUP

#### Setting up the frequencies manually

1. Ensure the main power switch on the rear panel is turned ON. Ensure the module is turned ON. Ensure the microphone is turned ON.

2. Press the MENU button on the module until group (GR) is visible in the display window.

3. Press the up and down buttons to select a group. ex: GR16 is GROUP 1-6, GR2A is GROUP 2-A

NOTE: The two left modules use GROUP 1 and the two right modules use GROUP 2.

4. Once a group is selected, press the MENU button until channel (CH) is visible in the display window.

5. When "CH" is visible, press the up and down buttons to select a channel. The number of channels varies from group to group.

6. Once a frequency channel has been selected, press the MENU button until "IR" is visible in the display window.

7. When only "IR" is visible in the display window, hold the microphone up to the module so there is a clear line of sight between the infrared (IR) sensors. Press the SET button to program the microphone. Hold the microphone up to the module until the RF bars show up in the display window.

NOTE: If the RF bars do not show up, make sure the microphone is turned on and that nothing is blocking the IR sensor, and attempt this step again.

8. Check the microphone by speaking into it. The AF bars in the display window should illuminate when you speak.

NOTE: After turning on a microphone, there is a 5 second delay before audio transmission.

9. Turn off the microphone (not the module) to test for outside interference. With the microphone off, if the RF indicator still has bars showing, there may be interference. If this happens, you need to select another frequency.

10. Repeat the process for the remaining modules and mics.

Once this process is complete, the microphones and modules will remain assigned to these frequencies until you change them.

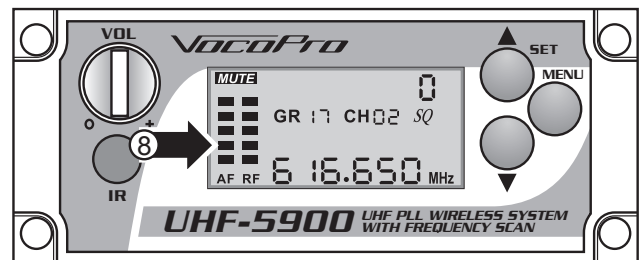
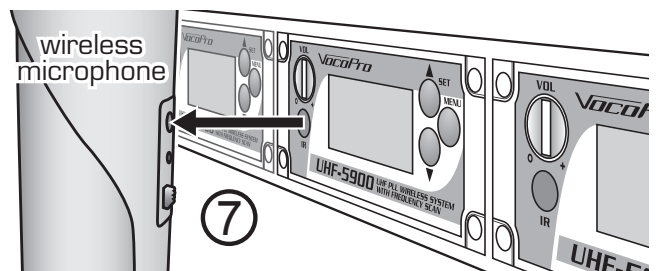
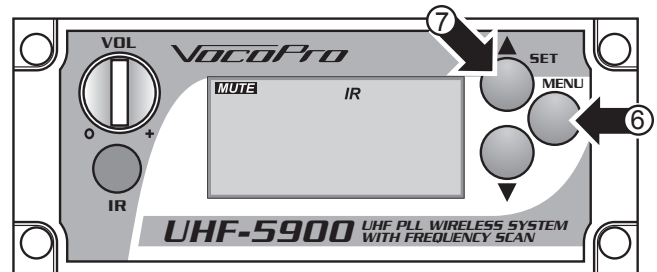
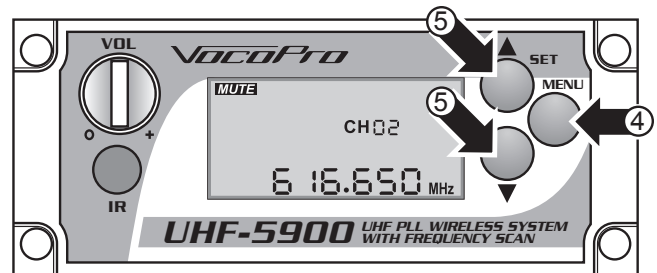
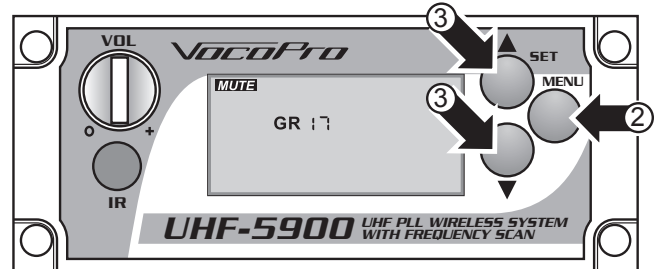

# Using the Wireless Mics

## Microphone Position

The UHF-5900 is ideal for close-up vocals and can be held in the hand or mounted on a mic stand. Keep in mind that microphone technique is largely a matter of personal taste, and there is no one "correct" microphone position.

## Feedback

Feedback occurs when the amplified sound from any loudspeaker reenters the sound system through any open microphone and is repeatedly amplified.

### Most commonly, feedback is caused by the following conditions:

- Placing loudspeakers too close to microphones.
- Having too many open active microphones.
- Boosting tone controls indiscriminately (mainly treble).
- Performing in areas with high ratios of room surfaces that have hard and reflective surfaces such as glass, marble and wood.

### What to do if feedback occurs before the sound system is loud enough:

- Request that the talker speak louder into the microphone.
- Reduce the distance from the talker to the microphone. Each time this distance is halved, the sound system output will increase by 6dB.
- Reduce the number of open microphones.
- Move the loudspeaker farther away from the microphone. Each time this distance is doubled, the sound system output can be increased by 6dB.
- Move the loudspeaker closer to the listener.
- Use an equalizer/feedback reducer to cut the frequency bands in which the feedback occurs.

## Microphone Placement & Tone Quality

### Lead & Backup Vocals

Lips should be less than 3" from or even touching the windscreen on an axis to the microphone. Doing this creates a robust sound, emphasizes bass and provides maximum isolation from other sources.

### Speech

When giving a speech or simply speaking, place the microphone 4" to 10" away from the mouth, just above nose height for a natural sound with reduced bass. You can also place the microphone 8" to 16" away from the mouth, slightly off to one side, for a more "distant" sound with highly reduced bass and minimal "s" sounds.

## Using the Squelch control

The Squelch control is used to mute unwanted noise interference from a microphone channel when the associated transmitter is turned off. Each channel has its own squelch control and should be set independently as necessary. Squelch can be set from 0 to 15, with 10-15 being represented by A-F.

### To adjust squelch:

- For each channel, start with the squelch control set at '0'. If not at '0', press and hold the DOWN ARROW until the display reads 'SQ 0'.
- Press and hold the UP ARROW until any noise interference has been successfully muted.
- You may need to turn the mic on/off to test if the squelch is at a sufficient level.

NOTE: Typically, as a channel's squelch setting increases, its operating range decreases. It is therefore recommended to set the squelch control only as high as necessary to mute any noise interference.



# Basic Operations

## Setting Up with Stage Monitors/P.A. System

If you will be using the UHF-5900 with stage monitors and/or a P.A. system, try the following:

- Place the stage monitor directly in front of the microphone.
- Locate the P.A. loudspeakers so that they point away from the rear of the microphone. (With the speakers located in these positions, the possibility of feedback is greatly reduced).
- Always check the stage setup before a performance to ensure optimum placement of microphone and monitors.

NOTE: Every wireless microphone installation is a unique situation, and can present a variety of problems. Never attempt a live performance without first conducting a "walkthrough" test of the system in the performing area. If major changes (additional wireless systems or intercoms, relocation of scenery, etc.) have been made since the last walk-through test, check the wireless system again, as close to performance time as possible.

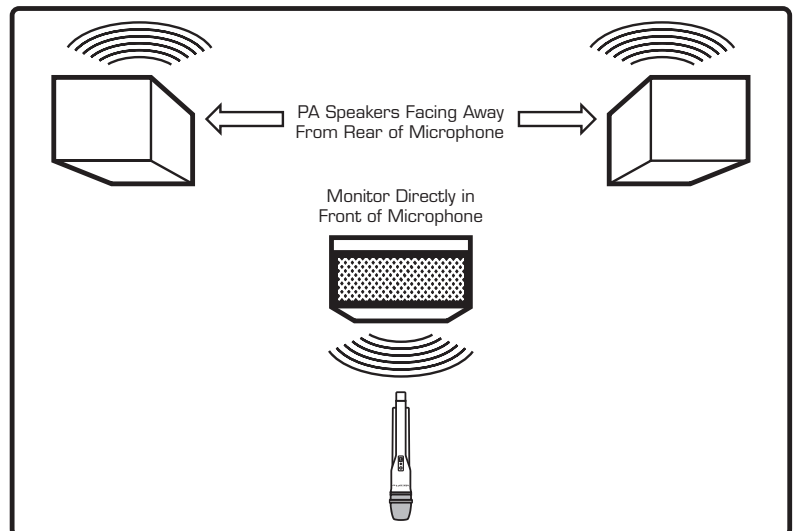

## Avoiding Interference

As with all RF devices, interference can be a problem. While some causes of interference are unavoidable, others can be avoided by taking certain precautions. Below are some helpful hints to avoid unwanted interference.

- Make sure that the operating frequencies used with your wireless system do not coincide with local TV station broadcast frequencies.
- If using multiple systems, or within range of other systems, check all wireless frequencies in use to make sure that no two frequencies are being used at the same time.
- For all operating frequencies, make sure there is at least 1 MHz between each frequency.
- Before using a system in a new location or another city, perform a walk-through to check for new problems.
- Check the squelch control setting on the receiver. A higher squelch setting provides better protection against interference. However, since a high setting also can cause a reduction in operating range, set the control to the lowest position that reliably mutes the interference.
- Make certain that all batteries are fresh and new. Weak batteries make a system more susceptible to interference.
- If not in use, power down electronic equipment such as computers, CD players, and other digital devices, as they are a common source of wireless interference; especially if they are in close proximity to the receiver.
- As much as feasible, keep computers and other digital devices at least 3 feet away from the wireless receiver and/or its antennas.

## Improving Range

To get the most usable range out of your wireless microphone system, follow the helpful hints below.

- Always try to keep an unobstructed line of site between the wireless receiver's antennas and the wireless transmitters. Metal objects between the wireless transmitters and receiver commonly reduce the operating range.
- When mounting the wireless receiver, avoid mounting it behind other electronic equipment, low to the ground, or in remote equipment/sound rooms.
- As far as feasible, minimize the amount of squelch applied to channels; the higher the squelch setting, the lesser the operating range.
- When operating the wireless system, keep all wireless transmitters at least 10 feet away from the receiver and its antennas. Wireless transmitters in close proximity can overload the receiver and reduce its overall sensitivity, as well as possibly cause interference with other channels on the system.
- Use only high-quality alkaline batteries in the wireless transmitters. Other types of batteries might not provide sufficient voltage and capacity for full power transmission.
- Position the receiver antennas so they do not touch each other.

# Advanced Operation

## Testing a Channel for Outside Interference

Once a microphone and module have been successfully paired, turn the microphone OFF (leave the module ON). With the microphone off, if the RF indicator still has bars showing, there exists interference. Note that RF interference can ebb and flow. Sometimes it may appear as 4 steady bars on the RF indicator; other times, it may weakly occupy a single bar or two. Generally, we recommend looking for another channel if ANY bars register.

## Using Automatic Frequency Selection

In some areas the auto-scan feature may not select an interference-free channel. This is not because the system is malfunctioning; it is because there are no interference-free channels available in that subgroup. If you are setting up in this kind of environment, and do not want to use manual frequency selection, we recommend you do the following:

1. Start an auto-scan on the left module (1) using GR11. If there is no open channel in that group, repeat an auto-scan on GR12. Continue this process until an open channel is selected. (see above for how to test a channel for interference)
2. Begin the auto-scan process on the 2nd module, but this time start with next available subgroup. For example, if on the 1st module you found an open channel on GR16, you would start scanning on GR17 on the 2nd module.
3. Repeat this process with the 3rd and 4th modules, starting with GR21.

## Obtaining Local TV Tower Information

The most common source of RF interference to the UHF-5900 is TV broadcast towers. If you are experiencing dropouts, static, or other annoying noises, and suspect RF interference, follow the instructions below to obtain information on your proximity to broadcasting TV towers (United States).

1. Visit <http://www.antennaweb.org> (see note below)
2. Click 'Choose an antenna'
3. Enter your zip code and hit 'Submit'
4. On the next screen, hit the 'Continue' button at the bottom of the map screen
5. On the next screen, under the 'RF Channel' tab, take note of any channels between 38 – 51.

After obtaining a list of locally active broadcast channels, cross reference it with the TV channel frequency list (Page 20). These frequency ranges are to be avoided as much as possible when selecting operating frequencies.

For example, let's say you did a search in your area (this example shows zip code 05456) and received the following information:

Show All Stations  Show Digital Stations Only  Show Analog Stations Only

DTV	Antenna Type	Call Sign	Channel	Network	City, State	Live Date	Compass Heading	Miles From	RF Channel
*	yellow uhf	WFFF-DT	44.1	FOX	BURLINGTON, VT		62°	29.7	43
*	yellow uhf	WCAX-DT	3.1	CBS	BURLINGTON, VT		62°	29.7	22
*	yellow uhf	WETK-DT	33.1	PBS	BURLINGTON, VT		62°	29.7	32
*	yellow vhf	WVNY-DT	22.1	ABC	BURLINGTON, VT		62°	29.7	13
*	yellow uhf	WPTZ-DT	5.1	NBC	NORTH POLE, NY		62°	29.7	14

The only relevant channel is 43, therefore you would jot it down to cross-reference with TV frequency chart (page 20)

After cross-referencing, you find that channel 43 uses the frequency range of 644 to 650 MHz. You would NOT choose a frequency that falls in that range.

NOTE: antennaweb.org is a third party website and is not maintained by or affiliated with VocoPro.

# UHF-5900 Frequency List

## GROUP 1

USED BY THE 2 LEFT MODULES



	GR1-1	GR1-2	GR1-3	GR1-4	GR1-5	GR1-6
<b>CH01</b>	614.025	614.425	615.025	615.275	615.525	615.775
<b>CH02</b>	615.400	616.350	616.004	618.525	617.275	617.775
<b>CH03</b>	617.150	618.025	622.650	619.900	619.275	620.025
<b>CH04</b>	622.025	623.100	636.650	623.400	653.900	626.400
<b>CH05</b>	625.650	628.900		639.400		629.025
<b>CH06</b>	648.150	633.675				641.275

	GR1-7	GR1-8	GR1-9	GR1-A	GR1-B	GR1-C
<b>CH01</b>	616.025	616.275	616.525	619.450	616.150	614.250
<b>CH02</b>	618.275	621.525	624.900	620.625	617.575	619.425
<b>CH03</b>	620.775	626.525	630.900	622.725	619.425	622.175
<b>CH04</b>	625.275	643.900	634.275	627.775	625.225	624.325
<b>CH05</b>	637.275	623.900	637.900	633.200	628.325	636.675
<b>CH06</b>	640.275		641.150	635.750	632.600	

## GROUP 2

USED BY THE 2 RIGHT MODULES



	GR2-1	GR2-2	GR2-3	GR2-4	GR2-5	GR2-6
<b>CH01</b>	656.675	657.275	658.675	657.675	655.675	657.675
<b>CH02</b>	660.925	662.925	664.825	659.725	659.975	663.750
<b>CH03</b>	662.725	664.825	670.825	665.825	661.925	666.600
<b>CH04</b>	671.425	669.450	677.825	671.775	670.450	672.425
<b>CH05</b>	673.825	675.825	678.900	678.825	672.975	674.825
<b>CH06</b>	680.550	685.125	680.500	679.450	677.675	681.575
<b>CH07</b>	683.125	691.225	687.175	681.725	679.550	686.075
<b>CH08</b>			691.675	692.800	690.425	692.500

	GR2-7	GR2-8	GR2-9	GR2-A	GR2-B	GR2-C
<b>CH01</b>	654.100	654.375	655.550	656.075	656.375	656.800
<b>CH02</b>	659.675	658.200	658.100	658.250	658.525	658.925
<b>CH03</b>	665.775	665.825	666.025	666.775	667.175	662.475
<b>CH04</b>	668.175	667.875	668.425	668.675	669.250	667.625
<b>CH05</b>	669.175	669.475	670.100	670.375	672.075	669.675
<b>CH06</b>	670.275	670.825	671.325	674.625	677.225	670.975
<b>CH07</b>	676.075	674.125	674.450	677.900	681.525	672.475
<b>CH08</b>	686.925	684.450	679.850	681.600	683.525	675.600
<b>CH09</b>	690.775	690.325	683.600	686.650	687.050	681.275
<b>CH10</b>	693.500	693.775	685.425	689.825	690.225	683.475
<b>CH11</b>			689.450	691.400	691.775	687.450
<b>CH12</b>						690.100
<b>CH13</b>						692.525

## TV Channel Frequencies (USA)

38 614-620 MHz

39 620-626 MHz

40 626-632 MHz

41 632-638 MHz

42 638-644 MHz

43 644-650 MHz

44 650-656 MHz

45 656-662 MHz

46 662-668 MHz

47 668-674 MHz

48 674-680 MHz

49 680-686 MHz

50 686-692 MHz

51 692-698 MHz

# Troubleshooting

## **There is no power**

- Make sure the power adapter cord is firmly connected to the back of the UHF-5900 and to the power outlet.
- If using a power strip/surge-protector, make sure that it is plugged in and switched on.
- Make sure the rear panel power switch and the front panel module power switches are turned on.

## **There is no sound**

- Make sure everything is connected firmly and properly.
- Make sure there are no defective cables.
- Make sure all of your components are turned on.
- Make sure all of the components (amp, mixer, TV, etc.) are set to the proper inputs.
- Make sure the microphones are set to the correct channels.
- Make sure the module volume is turned up.

## **The sound cuts out, is unclear, or has static**

- Make sure everything is connected firmly and properly.
- Position the antennas 90° from each other. (see illustration on page 13)
- Make sure there are no defective cables.
- Make sure the microphone batteries are fresh and fully charged.
- Increase the squelch on the affected channel. (see page 16)
- Make sure each module is set to a different frequency. Do not assign more than one mic to a module.
- Try a different wireless frequency channel.

## **Burst of static when turning off a microphone**

- Increase the squelch on the affected channel. (see page 16)
- Make sure microphones are at least 1ft from each other.
- Make sure the microphones are at least 5ft from the receiver.

## **Can't find an interference free frequency**

- Refer to obtaining information on your proximity to TV broadcast towers. (see page 18)

## **The microphone will not set to the desired frequency**

- Make sure the microphone has charged batteries.
- Make sure nothing is blocking the the infrared sensors.
- Hold the microphone closer to the module with the IR sensors facing each other.
- Try a different wireless frequency channel.

## **Audio from one microphone bleeds into another channel**

- Make sure the microphone is at least 10 feet from the receiver.
- Make sure that the mic frequency is at least 1MHz away from the frequencies of the other mics.

## **Module is stuck in scan mode**

- Reset the module by turning it off and on.

## **Buttons are not responsive**

- Make sure the buttons are not stuck.
- Reset the module by turning it off and on.

Notes

# Notes

# ***VocoPro***<sup>®</sup>

---

**PROFESSIONAL VOCAL SYSTEMS**<sup>™</sup>

